

FLEXALIGHTING

smart
news
2024

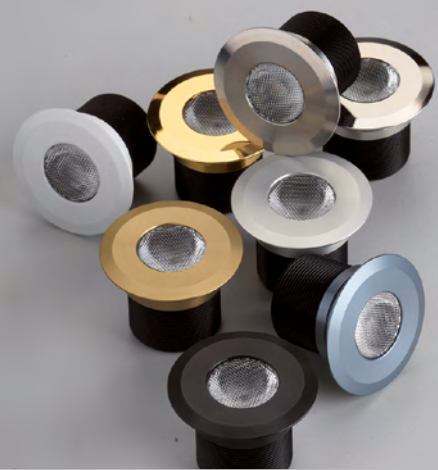

FLUSH OPTIC
DOWNLIGHTS



RECESSED OPTIC
DOWNLIGHTS



TRIMLESS
DOWNLIGHTS



STEPLIGHTS



LINEAR
SYSTEMS



CEILING MOUNTED



UPLIGHTS &
PATHLIGHTS



DIM TO
WARM



Alphabetical index

- ▶ Birdie
- ▶ Cyl 10
- ▶ Esme
- ▶ Flexus 20
- ▶ Flexus DTW
- ▶ Franny 20
- ▶ Franny DTW
- ▶ Fronk
- ▶ Jos R DTW
- ▶ Jos S DTW
- ▶ Lad R DTW
- ▶ Lad S DTW
- ▶ Landa 2
- ▶ Minijos R DTW
- ▶ Minijos S DTW
- ▶ Nexus
- ▶ Plexus UGR DTW
- ▶ Sexus UGR DTW
- ▶ Zoe 20
- ▶ Zoe DTW

FLUSH OPTIC DOWNLIGHTS



FLEXUS 20
20W IP44

RECESSED OPTIC DOWNLIGHTS



FRANNY 20
20W IP44

TRIMLESS DOWNLIGHTS



ZOE 20
20W IP44

STEPLIGHTS



BIRDIE
1W IP40



BIRDIE TRIMLESS
1W IP40

LINEAR SYSTEM



**ESME
PRECISION T10**
10W IP20



**ESME
PRECISION T20**
20W IP20



**ESME
PERFORMANCE T10**
10W IP20



**ESME
PERFORMANCE T20**
20W IP20

CEILING MOUNTED



CYL 10
10W IP20

UPLIGHTS & PATHLIGHTS



LANDA 2
2W IP67



FRONK
2W IP67



NEXUS 6
6W IP67

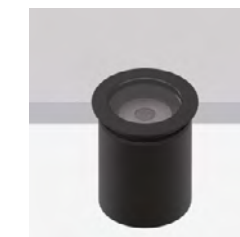

NEXUS 10
10W IP67

DIM TO WARM



FLEXUS DTW
8W IP44



FRANNY DTW
8W IP44



ZOE DTW
8W IP44



SEXUS UGR DTW
8W IP44

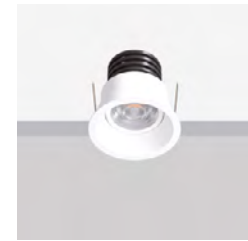

PLEXUS UGR DTW
8W IP44

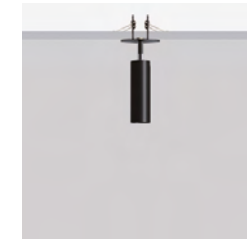

MINIJOS R DTW
8W IP20



JOS R DTW
8W IP20



LAD R DTW
8W IP20



MINIJOS S DTW
8W IP20



JOS S DTW
8W IP20



LAD S DTW
8W IP20

FLEXUS 20

design: Rod&Todd



[DATASHEET](#)

[INSTALLATION MANUAL](#)

[CERTIFICATIONS](#)

[LDT-IES](#) [DRAWINGS](#)

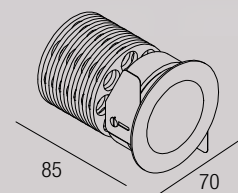

Flush optic downlight
 20W · 500mA (V, 36V)
 CRI95 · 2-Step MacAdam

2700K — 1830 lm
 3000K — 2000 lm
 4000K — 2100 lm

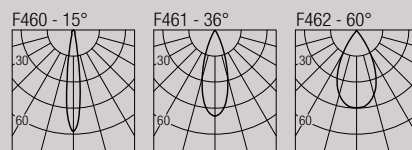

Code Construction - Costruzione del codice

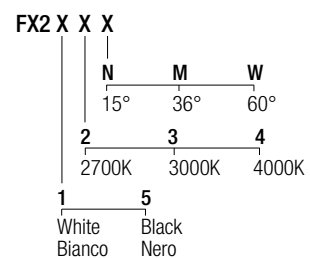

Accessories - Accessori

LFX201
 Low luminance louver
 Filtro antiabbagliamento



SFX201
 Milky screen - Schermo opale



Note - Nota
 The filter and the screen must be ordered together with the lighting fixture - Il filtro e lo schermo devono essere ordinati congiuntamente all'apparecchio.

Drivers - Alimentatori 500mA

- on/off
AL1084 (1) IP20 S.P. ⌀ 55 mm
 dimmable
AL4010 (1) IP20 PUSH 0/1..10V ⌀ 72 mm
ALB451 (1) IP20 DALI 2 PUSH ⌀ 46 mm
AL4151 (1) IP20 DALI 2 ⌀ 72 mm
AL4153 (1) IP20 PUSH IGBT-TRIAC ⌀ 56 mm



FRANNY 20

design: Rod&Todd



[DATASHEET](#)

[INSTALLATION MANUAL](#)

[CERTIFICATIONS](#)

[LDT-IES](#) [DRAWINGS](#)

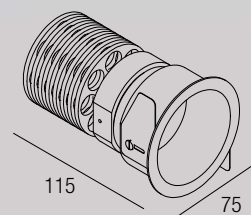

Recessed optic downlight

20W · 500mA (V, 36V)
CRI95 · 2-Step MacAdam

2700K — 1830 lm
3000K — 2000 lm
4000K — 2100 lm

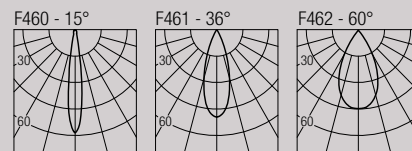

Code Construction - Costruzione del codice

FN2		X	X	X
N		M	W	
15°		36°	60°	
2	3	4		
2700K		3000K	4000K	
1	5			
White	Black			
Bianco	Nero			

Accessories - Accessori

LFN201
Low luminance louver
Filtro antiabbagliamento



SFN201
Milky screen - Schermo opale



Note - Nota
The filter and the screen must be ordered together with the lighting fixture - Il filtro e lo schermo devono essere ordinati congiuntamente all'apparecchio.

Drivers - Alimentatori 500mA

on/off
AL1084 (1) IP20 S.P. ∅55 mm
dimmable
AL4010 (1) IP20 PUSH 0/1..10V ∅72 mm
ALB451 (1) IP20 DALI 2 PUSH ∅46 mm
AL4151 (1) IP20 DALI 2 ∅72 mm
AL4153 (1) IP20 PUSH IGBT-TRIAC ∅56 mm



ZOE 20

design: Rod&Todd

IP44

[DATASHEET](#)

[INSTALLATION MANUAL](#)

[CERTIFICATIONS](#)

[LDT-IES](#) [DRAWINGS](#)

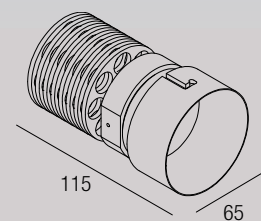

Trimless downlight
20W · 500mA (V, 36V)
CRI95 · 2-Step MacAdam

2700K — 1830 lm
3000K — 2000 lm
4000K — 2100 lm

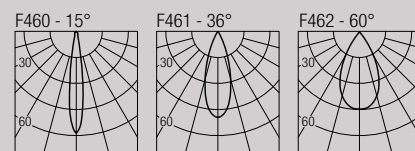

Code Construction - Costruzione del codice

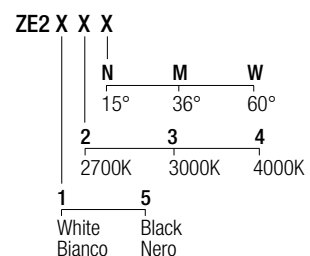

Accessories - Accessori

ZQSU002 White - Bianco
ZQSU002B Black - Nero
Plasterboard recessing frame
Flangia per cartongesso

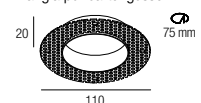

LZE201
Low luminance louver
Filtro antiabbagliamento



SZE201
Milky screen - Schermo opale



Note - Nota
The filter and the screen must be ordered together with the lighting fixture - Il filtro e lo schermo devono essere ordinati congiuntamente all'apparecchio.

Drivers - Alimentatori 500mA

on/off
AL1084 (1) IP20 S.P. 55 mm
dimmiabile
AL4010 (1) IP20 PUSH 0/1..10V 72 mm
ALB451 (1) IP20 DALI 2 PUSH 46 mm
AL4151 (1) IP20 DALI 2 72 mm
AL4153 (1) IP20 PUSH IGBT-TRIAC 56 mm



BIRDIE

design: Jude Allen



[DATASHEET](#)

[INSTALLATION MANUAL](#)

[CERTIFICATIONS](#)

[LDT-IES](#)

[DRAWINGS](#)

Steplight

1-2W · 350-500mA (V, 2,9V) · Series wiring - Cablaggio in serie
CRI85 · 2-Step MacAdam

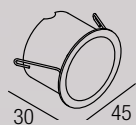

	350mA	500mA
2700K	116 lm	166 lm
3000K	124 lm	177 lm
4200K	137 lm	204 lm

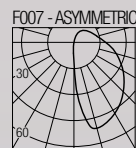

Code Construction - Costruzione del codice

BDE X X

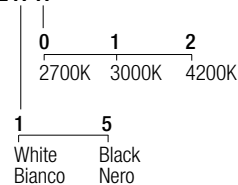

Accessories - Accessori

CSDS05

Recessing box - Controcassa

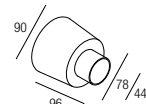

AL7022

24VDC/500mA constant current converter
Convertitore 24VDC/500mA corrente costante

Drivers - Alimentatori 350mA

on/off

- AL1034** (1..11) IP20 ⌀ 30 mm
- AL1035** (1..11) IP20 ⌀ 40 mm
- AL1037** (1..16) IP20 S.P. ⌀ 55 mm

dimmable

- AL4000** (1..12) IP20 PUSH 0/1..10V ⌀ 72 mm
- ALD435** (1..11) IP20 DALI 2 PUSH ⌀ 36 mm
- AL4051** (2..14) IP20 DALI 2 ⌀ 72 mm
- AL4053** (1..14) IP20 PUSH IGBT-TRIAC ⌀ 56 mm

Drivers - Alimentatori 500mA

on/off

- AL1074** (1..7) IP20 ⌀ 30 mm
- AL1077** (1..6) IP20 ⌀ 40 mm
- AL1084** (1..11) IP20 S.P. ⌀ 55 mm

dimmable

- AL4010** (1..12) IP20 PUSH 0/1..10V ⌀ 72 mm
- ALD450** (1..7) IP20 DALI 2 PUSH ⌀ 36 mm
- AL4151** (2..14) IP20 DALI 2 ⌀ 72 mm
- AL4153** (1..14) IP20 PUSH IGBT-TRIAC ⌀ 56 mm

BIRDIE TRIMLESS

design: Jude Allen



[DATASHEET](#)

[INSTALLATION MANUAL](#)

[CERTIFICATIONS](#)

[LDT-IES](#)

[DRAWINGS](#)

Trimless steplight

1-2W · 350-500mA (V, 2,9V) · Series wiring - Cablaggio in serie
CRI85 · 2-Step MacAdam

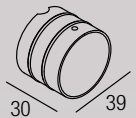

	350mA	500mA
2700K	116 lm	166 lm
3000K	124 lm	177 lm
4200K	137 lm	204 lm

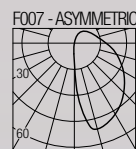

Code Construction - Costruzione del codice

BDT X X

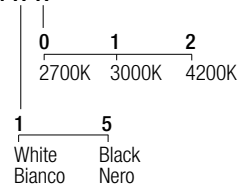

Accessories - Accessori

BQC001 White - Bianco

BQC001B Black - Nero

Plasterboard recessing frame
Flangia per cartongesso

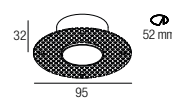

AL7022

24VDC/500mA constant current converter
Convertitore 24VDC/500mA corrente costante

Drivers - Alimentatori 350mA

on/off

- AL1034** (1..11) IP20 ⌀ 30 mm
- AL1035** (1..11) IP20 ⌀ 40 mm
- AL1037** (1..16) IP20 S.P. ⌀ 55 mm

dimmable

- AL4000** (1..12) IP20 PUSH 0/1..10V ⌀ 72 mm
- ALD435** (1..11) IP20 DALI 2 PUSH ⌀ 36 mm
- AL4051** (2..14) IP20 DALI 2 ⌀ 72 mm
- AL4053** (1..14) IP20 PUSH IGBT-TRIAC ⌀ 56 mm

Drivers - Alimentatori 500mA

on/off

- AL1074** (1..7) IP20 ⌀ 30 mm
- AL1077** (1..6) IP20 ⌀ 40 mm
- AL1084** (1..11) IP20 S.P. ⌀ 55 mm

dimmable

- AL4010** (1..12) IP20 PUSH 0/1..10V ⌀ 72 mm
- ALD450** (1..7) IP20 DALI 2 PUSH ⌀ 36 mm
- AL4151** (2..14) IP20 DALI 2 ⌀ 72 mm
- AL4153** (1..14) IP20 PUSH IGBT-TRIAC ⌀ 56 mm



ESME PRECISION T10

design: Jude Allen

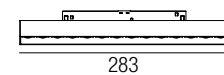

Linear module for 24VDC tracks
10W · 24VDC
CRI95 · 3-Step MacAdam

2700K — 946 lm
3000K — 1005 lm
4000K — 1157 lm

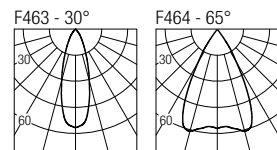

Code Construction - Costruzione del codice

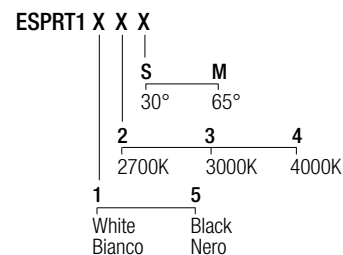

- [DATASHEET](#)
- [INSTALLATION MANUAL](#)
- [CERTIFICATIONS](#)
- [LDT-IES](#)
- [DRAWINGS](#)

ESME PERFORMANCE T10

design: Jude Allen

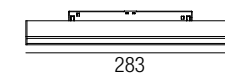

Linear module for 24VDC tracks
10W · 24VDC
CRI95 · 3-Step MacAdam

2700K — 825 lm
3000K — 865 lm
4000K — 985 lm

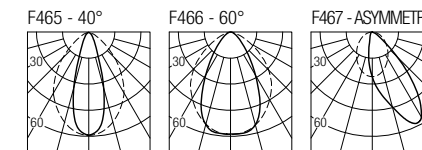

Code Construction - Costruzione del codice

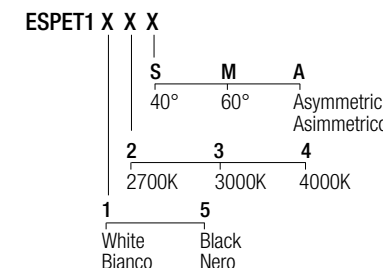

- [DATASHEET](#)
- [INSTALLATION MANUAL](#)
- [CERTIFICATIONS](#)
- [LDT-IES](#)
- [DRAWINGS](#)

ESME PRECISION T20

design: Jude Allen

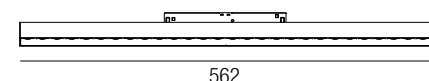

Linear module for 24VDC tracks
20W · 24VDC
CRI95 · 3-Step MacAdam

2700K — 1892 lm
3000K — 2010 lm
4000K — 2314 lm

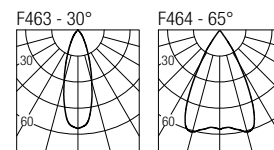

Code Construction - Costruzione del codice

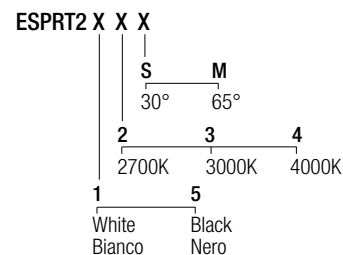

- [DATASHEET](#)
- [INSTALLATION MANUAL](#)
- [CERTIFICATIONS](#)
- [LDT-IES](#)
- [DRAWINGS](#)

ESME PERFORMANCE T20

design: Jude Allen



Linear module for 24VDC tracks
20W · 24VDC
CRI95 · 3-Step MacAdam

2700K — 1650 lm
3000K — 1730 lm
4000K — 1970 lm

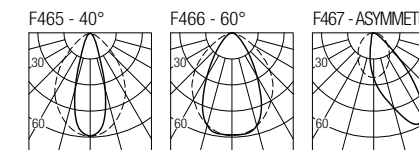

Code Construction - Costruzione del codice

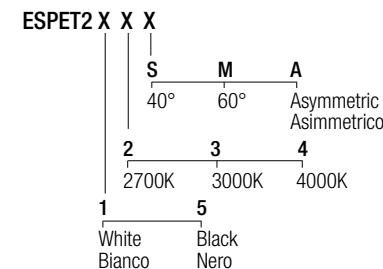

- [DATASHEET](#)
- [INSTALLATION MANUAL](#)
- [CERTIFICATIONS](#)
- [LDT-IES](#)
- [DRAWINGS](#)

CYL 10

design: Roberto Mantovani



[DATASHEET](#)

[INSTALLATION MANUAL](#)

[CERTIFICATIONS](#)

[LDT-IES](#) [DRAWINGS](#)

Ceiling mounted luminaire

10W · 500mA (V, 18V) · Series wiring - Cablaggio in serie
CRI85 - CRI93 · 2-Step MacAdam

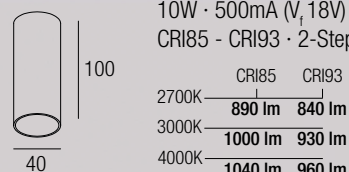

	CRI85	CRI93
2700K	890 lm	840 lm
3000K	1000 lm	930 lm
4000K	1040 lm	960 lm

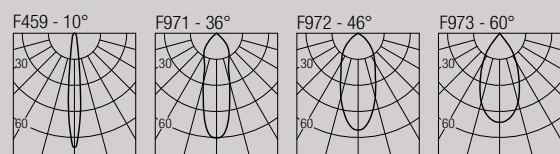

Code Construction - Costruzione del codice

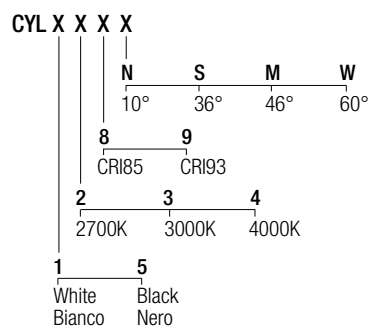

Accessories - Accessori

LCYL01 White - Bianco
LCYL01B Black - Nero
Low luminance louver
Filtro antiabbagliamento



SCYL01 White - Bianco
SCYL01B Black - Nero
Milky screen - Schermo opale



Note - Nota
The filter and screen are not compatible with the 10° lens version - Il filtro e lo schermo non sono compatibili con la versione con ottica 10°.

AL7022
24VDC/500mA constant current converter
Convertitore 24VDC/500mA corrente costante

Drivers - Alimentatori 500mA

on/off
AL1074 (1) IP20 ⌀30 mm
AL1077 (1) IP20 ⌀40 mm
AL1084 (1..2) IP20 S.P. ⌀55 mm
dimmmable
AL4010 (1..2) IP20 PUSH 0/1..10V ⌀72 mm
ALD450 (1) IP20 DALI 2 PUSH ⌀36 mm
AL4151 (1..2) IP20 DALI 2 ⌀72 mm
AL4153 (1..2) IP20 PUSH IGBT-TRIAC ⌀56 mm



LANDA 2

design: Roberto Mantovani



[DATASHEET](#)

[INSTALLATION MANUAL](#)

[CERTIFICATIONS](#)

[LDT-IES](#) [DRAWINGS](#)

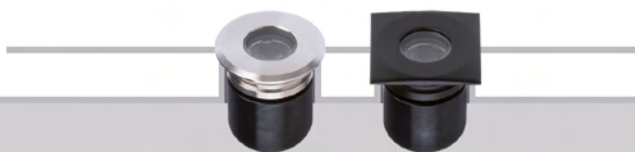

Uplight

2W · 500mA (V, 2,9V) · Series wiring - Cablaggio in serie
CRI85 · 2-Step MacAdam

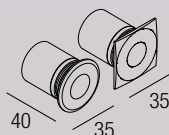

2700K	175 lm
3000K	181 lm
4200K	197 lm
6000K	211 lm

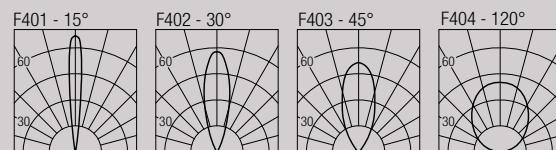

Code Construction - Costruzione del codice

L2A X X X X

G	N	K	Z
Grey Grigio	Black Nero	COR-TEN	INOX Steel AISI 316L
0	1	2	3
2700K	3000K	4200K	6000K
6	7	8	
Blue Blu	Green Verde	Red Rosso	
1	2	3	9
15°	30°	45°	120°
1	2		
Round Tondo	Square Quadrato		

Accessories - Accessori

CSLN01
Recessing box - Controcassa

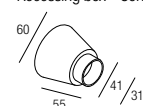

LL2A01
Low luminance louver
Filtro antiabbagliamento

Note - Nota
The filter must be ordered together with the lighting fixture. Il filtro deve essere ordinato congiuntamente all'apparecchio.

Note - Nota
Made-to-measure cable available on request. Cavo a misura disponibile su richiesta.

Drivers - Alimentatori 500mA

- on/off
- AL1074** (1..7) IP20 ⌀ 30 mm
 - AL1077** (1..6) IP20 ⌀ 40 mm
 - AL1084** (1..11) IP20 S.P. ⌀ 55 mm
 - AL9051** (1..11) IP67 ⌀ 44 mm
- dimmable
- AL4010** (1..12) IP20 PUSH 0/1..10V ⌀ 72 mm
 - ALD450** (1..7) IP20 DALI 2 PUSH ⌀ 36 mm
 - AL4151** (2..14) IP20 DALI 2 ⌀ 72 mm
 - AL4153** (1..14) IP20 PUSH IGBT-TRIAC ⌀ 56 mm
 - AL6050** (2..6) IP67 DALI 2 ⌀ 44 mm
 - AL8050** (4..16) IP67 DALI 2 ⌀ 48 mm

FRONK

design: Roberto Mantovani



[DATASHEET](#)

[INSTALLATION MANUAL](#)

[CERTIFICATIONS](#)

[LDT-IES](#) [DRAWINGS](#)

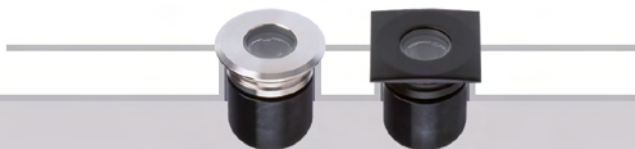

Uplight

2W · 24VDC · Parallel wiring - Cablaggio in parallelo
CRI85 · 2-Step MacAdam

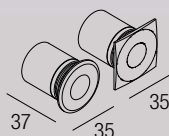

2700K	128 lm
3000K	133 lm
4000K	154 lm

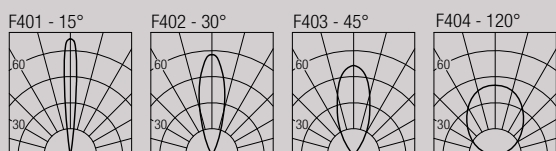

Code Construction - Costruzione del codice

FNK X X X X

G	N	K	Z
Grey Grigio	Black Nero	COR-TEN	INOX Steel AISI 316L
0	1	2	
2700K	3000K	4000K	
1	2	3	9
15°	30°	45°	120°
1	2		
Round Tondo	Square Quadrato		

Accessories - Accessori

CSLN01
Recessing box - Controcassa

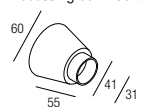

LFNK01
Low luminance louver
Filtro antiabbagliamento

Note - Nota
The filter must be ordered together with the lighting fixture. Il filtro deve essere ordinato congiuntamente all'apparecchio.

Note - Nota
Made-to-measure cable available on request. Cavo a misura disponibile su richiesta.

Drivers - Alimentatori 24VDC

- on/off
- AL2124** (1..5) IP20 ⌀ 28 mm
 - AL2012** (1..12) IP20 ⌀ 60 mm
 - AL2031** (1..35) IP20 ⌀ 70 mm
 - AL9222** (1..18) IP67 ⌀ 44 mm
 - AL9231** (1..35) IP67 ⌀ 85 mm
- dimmable
- AL5012** (1..12) IP20 DALI 2 PUSH 0/1..10V ⌀ 45 mm
 - AL8012** (1..12) IP67 DALI 2 ⌀ 48 mm
- dimming module
- AL7035** IP20 DALI 2 PUSH 0/1..10V ⌀ 44 mm
- Note - Nota
Dimming module AL7035 to be used in combination with a 24VDC power supply. Modulo di dimmerazione AL7035 da utilizzare in combinazione con un alimentatore 24VDC.



NEXUS 6

design: Rod&Todd



[DATASHEET](#)

[INSTALLATION MANUAL](#)

[CERTIFICATIONS](#)

[LDT-IES](#)

[DRAWINGS](#)

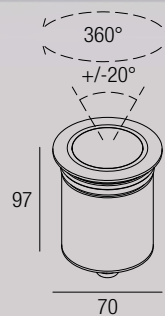

Adjustable uplight

6W · 500mA (V, 9V) · Series wiring - Cablaggio in serie
CRI98 · 2-Step MacAdam

2700K **540 lm**
3000K **600 lm**
4000K **620 lm**

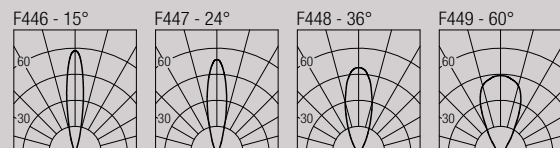

Code Construction - Costruzione del codice

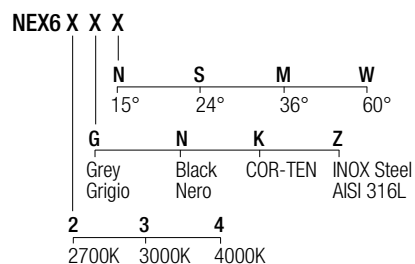

Accessories - Accessori

CSXJ01
Recessing box - Controcassa

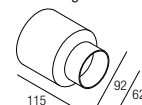

LNEX601
Low luminance louver
Filtro antiabbagliamento

Note - Nota
The filter must be ordered together with the lighting fixture.
Il filtro deve essere ordinato congiuntamente all'apparecchio.

Note - Nota
Made-to-measure cable available on request.
Cavo a misura disponibile su richiesta.

Drivers - Alimentatori 500mA

- on/off
- AL1074** (1..2) IP20 ⌀ 30 mm
 - AL1077** (1..2) IP20 ⌀ 40 mm
 - AL1084** (1..3) IP20 S.P. ⌀ 55 mm
 - AL9051** (1..3) IP67 ⌀ 44 mm
- dimmmable
- AL4010** (1..4) IP20 PUSH 0/1..10V ⌀ 72 mm
 - ALD450** (1..2) IP20 DALI 2 PUSH ⌀ 36 mm
 - AL4151** (1..4) IP20 DALI 2 ⌀ 72 mm
 - AL4153** (1..4) IP20 PUSH IGBT-TRIAC ⌀ 56 mm
 - AL6050** (1..2) IP67 DALI 2 ⌀ 44 mm
 - AL8050** (2..4) IP67 DALI 2 ⌀ 48 mm

NEXUS 10

design: Rod&Todd



[DATASHEET](#)

[INSTALLATION MANUAL](#)

[CERTIFICATIONS](#)

[LDT-IES](#)

[DRAWINGS](#)

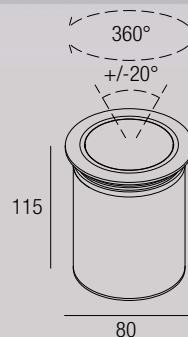

Adjustable uplight

10W · 500mA (V, 18V) · Series wiring - Cablaggio in serie
CRI85 - CRI93 · 2-Step MacAdam

CRI85 CRI93
2700K **890 lm** **840 lm**
3000K **1000 lm** **930 lm**
4000K **1040 lm** **960 lm**

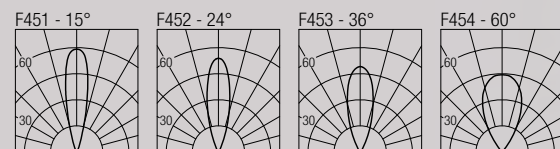

Code Construction - Costruzione del codice

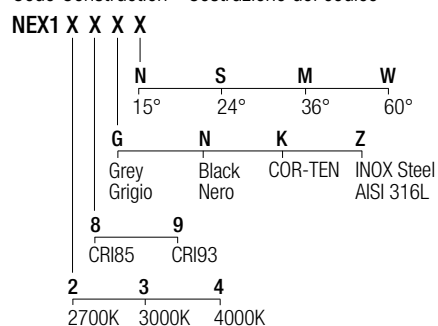

Accessories - Accessori

CSXJ02
Recessing box - Controcassa

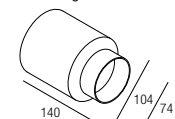

LNEX101
Low luminance louver
Filtro antiabbagliamento

Note - Nota
The filter must be ordered together with the lighting fixture.
Il filtro deve essere ordinato congiuntamente all'apparecchio.

Note - Nota
Made-to-measure cable available on request.
Cavo a misura disponibile su richiesta.

Drivers - Alimentatori 500mA

- on/off
- AL1074** (1) IP20 ⌀ 30 mm
 - AL1077** (1) IP20 ⌀ 40 mm
 - AL1084** (1..2) IP20 S.P. ⌀ 55 mm
 - AL9051** (1..2) IP67 ⌀ 44 mm
- dimmmable
- AL4010** (1..2) IP20 PUSH 0/1..10V ⌀ 72 mm
 - ALD450** (1) IP20 DALI 2 PUSH ⌀ 36 mm
 - AL4151** (1..2) IP20 DALI 2 ⌀ 72 mm
 - AL4153** (1..2) IP20 PUSH IGBT-TRIAC ⌀ 56 mm
 - AL6050** (1) IP67 DALI 2 ⌀ 44 mm
 - AL8050** (1..2) IP67 DALI 2 ⌀ 48 mm



FLEXUS DTW

design: Rod&Todd

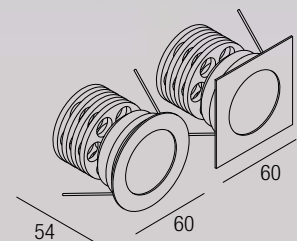

Dim to Warm flush optic downlight

8W · 400mA (V, 18V) · Series wiring - Cablaggio in serie
CRI95 · DTW 3000K to 1800K

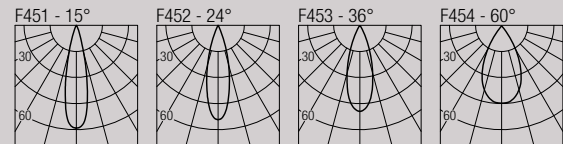
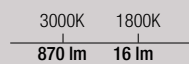

[DATASHEET](#)

[INSTALLATION MANUAL](#)

[CERTIFICATIONS](#)

[LDT-IES](#) [DRAWINGS](#)

DIM TO WARM

ZOE DTW

design: Rod&Todd

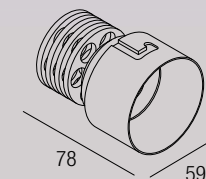

Dim to Warm trimless downlight

8W · 400mA (V, 18V) · Series wiring - Cablaggio in serie
CRI95 · DTW 3000K to 1800K

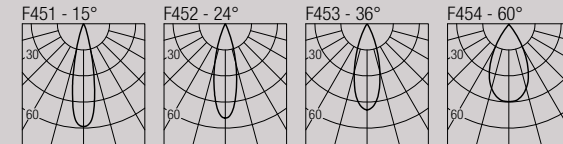
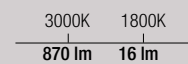

[DATASHEET](#)

[INSTALLATION MANUAL](#)

[CERTIFICATIONS](#)

[LDT-IES](#) [DRAWINGS](#)

Code Construction - Costruzione del codice

DTWFX1 X X X

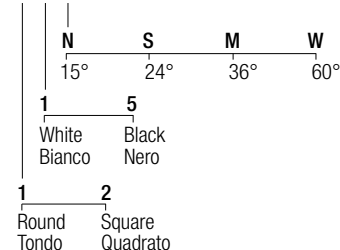

Accessories - Accessori

CSFX01

Recessing box - Controcassa

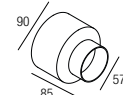

LDFX101

Low luminance louver
Filtro antiabbagliamento



SDFX101

Milky screen - Schermo opale



Note - Nota
The filter and the screen must be ordered together with the lighting fixture - Il filtro e lo schermo devono essere ordinati congiuntamente all'apparecchio.

Drivers - Alimentatori 400mA

dimmmable

AL4451 (1..2) IP20 DALI 2 50 mm

Code Construction - Costruzione del codice

DTWZE1 X X

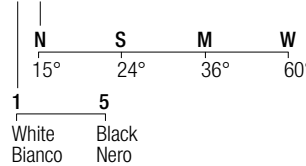

Accessories - Accessori

ZQC003 White - Bianco

ZQC003B Black - Nero

Plasterboard recessing frame
Flangia per cartongesso

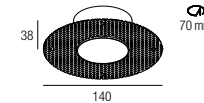

LDZE101

Low luminance louver
Filtro antiabbagliamento



SDZE101

Milky screen - Schermo opale



Note - Nota
The filter and the screen must be ordered together with the lighting fixture - Il filtro e lo schermo devono essere ordinati congiuntamente all'apparecchio.

Drivers - Alimentatori 400mA

dimmmable

AL4451 (1..2) IP20 DALI 2 50 mm

FRANNY DTW

design: Rod&Todd

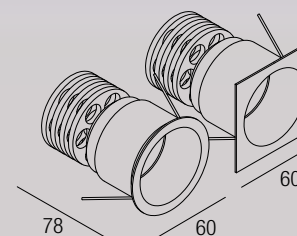

Dim to Warm recessed optic downlight

8W · 400mA (V, 18V) · Series wiring - Cablaggio in serie
CRI95 · DTW 3000K to 1800K

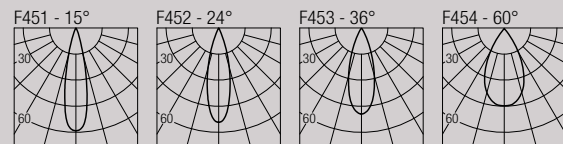
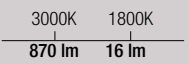

[DATASHEET](#)

[INSTALLATION MANUAL](#)

[CERTIFICATIONS](#)

[LDT-IES](#) [DRAWINGS](#)

Code Construction - Costruzione del codice

DTWFN1 X X X

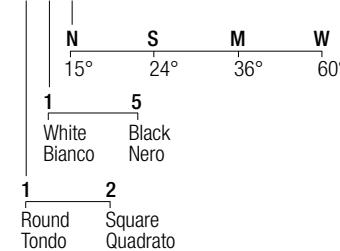

Accessories - Accessori

CSFX01

Recessing box - Controcassa

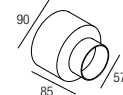

LDFN101

Low luminance louver
Filtro antiabbagliamento



SDFN101

Milky screen - Schermo opale



Note - Nota
The filter and the screen must be ordered together with the lighting fixture - Il filtro e lo schermo devono essere ordinati congiuntamente all'apparecchio.

Drivers - Alimentatori 400mA

dimmmable

AL4451 (1..2) IP20 DALI 2 50 mm

SEXUS UGR DTW

design: Rod&Todd

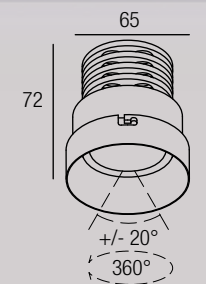

Dim to Warm trimless & adjustable downlight

8W · 400mA (V, 18V) · Series wiring - Cablaggio in serie
CRI95 · DTW 3000K to 1800K

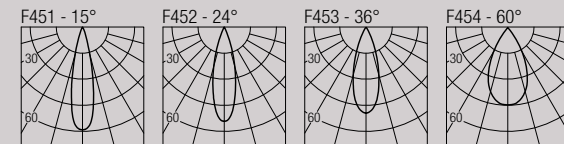
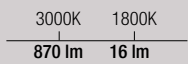

[DATASHEET](#)

[INSTALLATION MANUAL](#)

[CERTIFICATIONS](#)

[LDT-IES](#) [DRAWINGS](#)

Code Construction - Costruzione del codice

DTWSXU1 X X

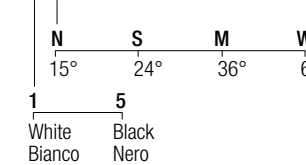

Accessories - Accessori

ZQSU002 White - Bianco

ZQSU002B Black - Nero

Plasterboard recessing frame
Flangia per cartongesso

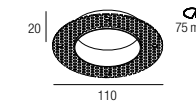

LDSXU101

Low luminance louver
Filtro antiabbagliamento



SDSXU101

Milky screen - Schermo opale



Note - Nota
The filter and the screen must be ordered together with the lighting fixture - Il filtro e lo schermo devono essere ordinati congiuntamente all'apparecchio.

Drivers - Alimentatori 400mA

dimmmable

AL4451 (1..2) IP20 DALI 2 50 mm

PLEXUS UGR DTW

design: Rod&Todd

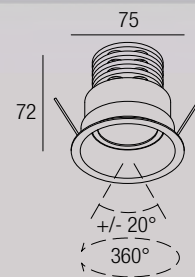

Dim to Warm adjustable downlight
8W · 400mA (V, 18V) · Series wiring - Cablaggio in serie
CRI95 · DTW 3000K to 1800K

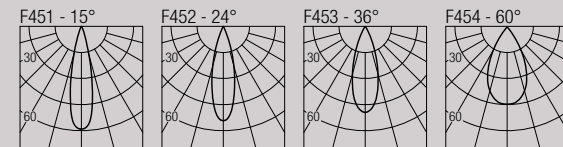
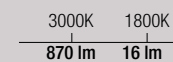

JOS R DTW

design: Roberto Mantovani

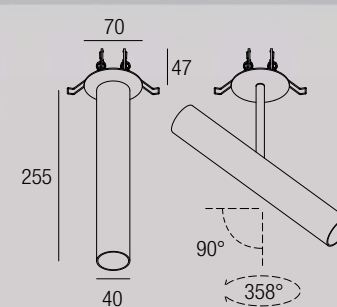

Dim to Warm semi-recessed projector
8W · 400mA (V, 18V) · Series wiring - Cablaggio in serie
CRI95 · DTW 3000K to 1800K

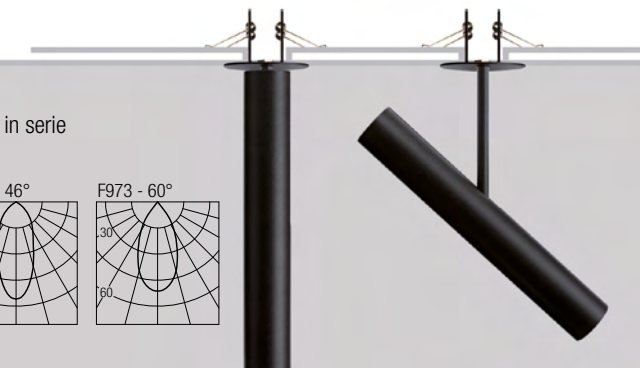
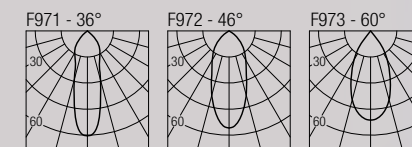

Code Construction - Costruzione del codice

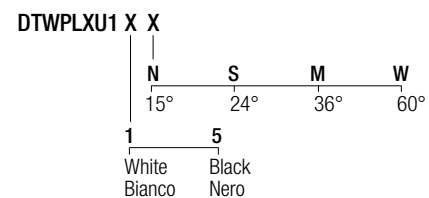

Accessories - Accessori

LDPLXU101
Low luminance louver
Filtro antiabbagliamento



SDPLXU101
Milky screen - Schermo opale



Note - Nota
The filter and the screen must be ordered together with the lighting fixture - Il filtro e lo schermo devono essere ordinati congiuntamente all'apparecchio.

Drivers - Alimentatori 400mA

dimmmable
AL4451 (1..2) IP20 DALI 2 ⌀ 50 mm

[DATASHEET](#)

[INSTALLATION MANUAL](#)

[CERTIFICATIONS](#)

[LDT-IES](#) [DRAWINGS](#)

Code Construction - Costruzione del codice

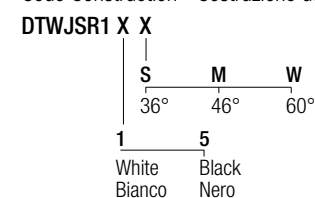

Note - Nota
Versions with extended arm length are available upon request. Versioni con lunghezza del braccetto maggiorata disponibili su richiesta.

Accessories - Accessori

LJ01 White - Bianco
LJ01B Black - Nero
Low luminance louver
Filtro antiabbagliamento



SJ01 White - Bianco
SJ01B Black - Nero
Milky screen - Schermo opale



Drivers - Alimentatori 400mA

dimmmable
AL4451 (1..2) IP20 DALI 2 ⌀ 50 mm

[DATASHEET](#)

[INSTALLATION MANUAL](#)

[CERTIFICATIONS](#)

[LDT-IES](#) [DRAWINGS](#)

MINIJOS R DTW

design: Roberto Mantovani

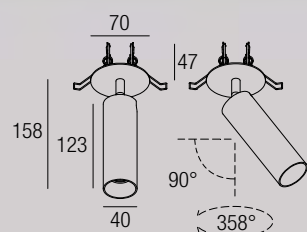

Dim to Warm semi-recessed projector
8W · 400mA (V, 18V) · Series wiring - Cablaggio in serie
CRI95 · DTW 3000K to 1800K

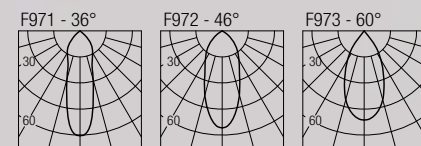

LAD R DTW

design: Roberto Mantovani

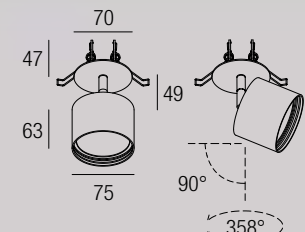

Dim to Warm semi-recessed projector
8W · 400mA (V, 18V) · Series wiring - Cablaggio in serie
CRI95 · DTW 3000K to 1800K

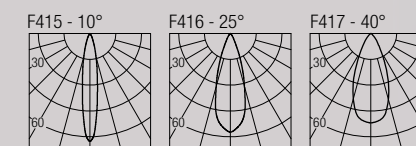

Code Construction - Costruzione del codice

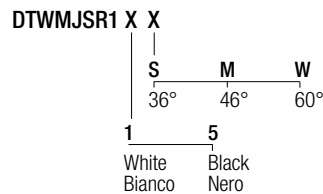

Note - Nota
Versions with extended arm length are available upon request. Versioni con lunghezza del braccetto maggiorata disponibili su richiesta.

Accessories - Accessori

LJ01 White - Bianco
LJ01B Black - Nero
Low luminance louver
Filtro antiabbagliamento



SJ01 White - Bianco
SJ01B Black - Nero
Milky screen - Schermo opale



Drivers - Alimentatori 400mA

dimmmable
AL4451 (1..2) IP20 DALI 2 ⌀ 50 mm

[DATASHEET](#)

[INSTALLATION MANUAL](#)

[CERTIFICATIONS](#)

[LDT-IES](#) [DRAWINGS](#)

Code Construction - Costruzione del codice

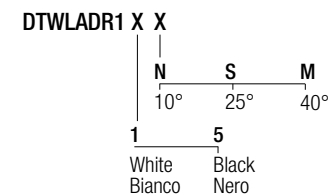

Note - Nota
Versions with extended arm length are available upon request. Versioni con lunghezza del braccetto maggiorata disponibili su richiesta.

Accessories - Accessori

LL01 White - Bianco
LL01B Black - Nero
Low luminance louver
Filtro antiabbagliamento



SL01 White - Bianco
SL01B Black - Nero
Milky screen - Schermo opale



Drivers - Alimentatori 400mA

dimmmable
AL4451 (1..2) IP20 DALI 2 ⌀ 50 mm

[DATASHEET](#)

[INSTALLATION MANUAL](#)

[CERTIFICATIONS](#)

[LDT-IES](#) [DRAWINGS](#)

MINIJOS S DTW

design: Roberto Mantovani

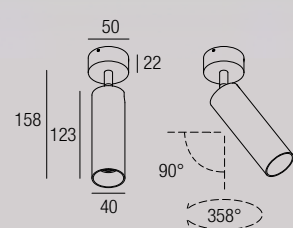

Dim to Warm surface projector

8W · 400mA (V, 18V) · Series wiring - Cablaggio in serie
CRI95 · DTW 3000K to 1800K

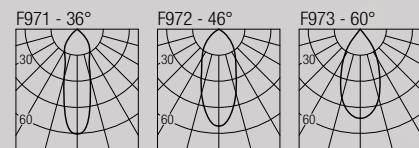
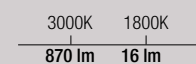

Code Construction - Costruzione del codice

DTWMJSS1 X X

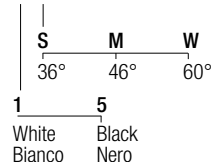

Note - Nota
Versions with extended arm length are available upon request. Versioni con lunghezza del braccetto maggiorata disponibili su richiesta.

Accessories - Accessori

LJ01 White - Bianco
LJ01B Black - Nero
Low luminance louver
Filtro antiabbagliamento



SJ01 White - Bianco
SJ01B Black - Nero
Milky screen - Schermo opale



Drivers - Alimentatori 400mA

dimnable
AL4451 (1..2) IP20 DALI 2 ⌀50 mm

[DATASHEET ▶](#)

[INSTALLATION MANUAL ▶](#)

[CERTIFICATIONS ▶](#)

[LDT-IES ▶](#) [DRAWINGS ▶](#)

LAD S DTW

design: Roberto Mantovani

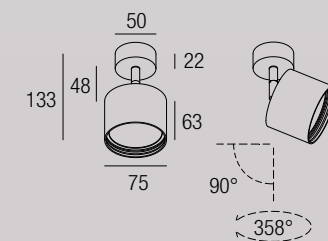

Dim to Warm surface projector

8W · 400mA (V, 18V) · Series wiring - Cablaggio in serie
CRI95 · DTW 3000K to 1800K

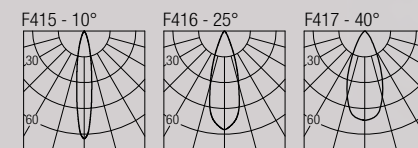

Code Construction - Costruzione del codice

DTWLADS1 X X

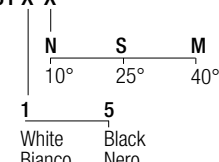

Note - Nota
Versions with extended arm length are available upon request. Versioni con lunghezza del braccetto maggiorata disponibili su richiesta.

Accessories - Accessori

LL01 White - Bianco
LL01B Black - Nero
Low luminance louver
Filtro antiabbagliamento



SL01 White - Bianco
SL01B Black - Nero
Milky screen - Schermo opale



Drivers - Alimentatori 400mA

dimnable
AL4451 (1..2) IP20 DALI 2 ⌀50 mm

[DATASHEET ▶](#)

[INSTALLATION MANUAL ▶](#)

[CERTIFICATIONS ▶](#)

[LDT-IES ▶](#) [DRAWINGS ▶](#)

JOS S DTW

design: Roberto Mantovani

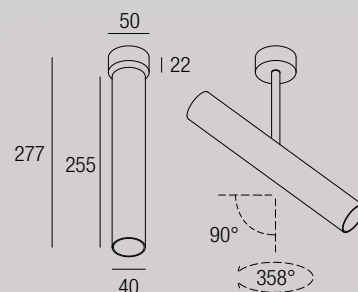

Dim to Warm surface projector

8W · 400mA (V, 18V) · Series wiring - Cablaggio in serie
CRI95 · DTW 3000K to 1800K

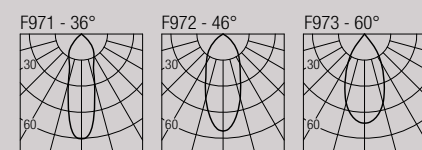
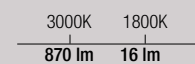

Code Construction - Costruzione del codice

DTWJSS1 X X

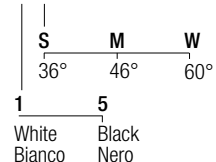

Note - Nota
Versions with extended arm length are available upon request. Versioni con lunghezza del braccetto maggiorata disponibili su richiesta.

Accessories - Accessori

LJ01 White - Bianco
LJ01B Black - Nero
Low luminance louver
Filtro antiabbagliamento



SJ01 White - Bianco
SJ01B Black - Nero
Milky screen - Schermo opale



Drivers - Alimentatori 400mA

dimnable
AL4451 (1..2) IP20 DALI 2 ⌀50 mm

[DATASHEET ▶](#)

[INSTALLATION MANUAL ▶](#)

[CERTIFICATIONS ▶](#)

[LDT-IES ▶](#) [DRAWINGS ▶](#)

FLEXA LIGHTING

PART OF
DEXELANCE

Via Lisbona 21
50065 Pontassieve
Firenze, Italy

ph +39.055.83.23.021
fax +39.055.83.24.866

- ▶ info@flexalighting.it
- ▶ www.flexalighting.net

