

# FLEXALIGHTING

smart  
news  
2024

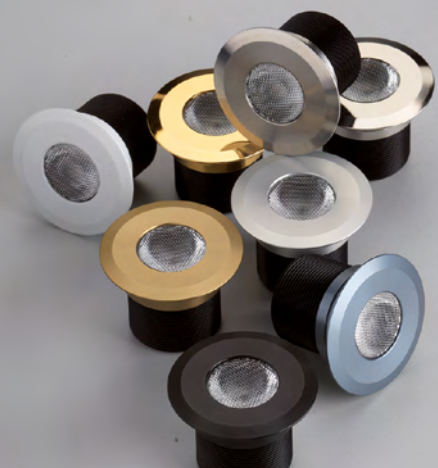

FLUSH OPTIC  
DOWNLIGHTS



RECESSED OPTIC  
DOWNLIGHTS



TRIMLESS  
DOWNLIGHTS



STEPLIGHTS



LINEAR  
SYSTEMS



CEILING MOUNTED



UPLIGHTS &  
PATHLIGHTS



DIM TO  
WARM



## Alphabetical index

- ▶ Birdie
- ▶ Cyl 10
- ▶ Esme
- ▶ Flexus 20
- ▶ Flexus DTW
- ▶ Franny 20
- ▶ Franny DTW
- ▶ Fronk
- ▶ Jos R DTW
- ▶ Jos S DTW
- ▶ Lad R DTW
- ▶ Lad S DTW
- ▶ Landa 2
- ▶ Minijos R DTW
- ▶ Minijos S DTW
- ▶ Nexus
- ▶ Plexus UGR DTW
- ▶ Sexus UGR DTW
- ▶ Zoe 20
- ▶ Zoe DTW

### FLUSH OPTIC DOWNLIGHTS



**FLEXUS 20**  
20W IP44

### RECESSED OPTIC DOWNLIGHTS



**FRANNY 20**  
20W IP44

### TRIMLESS DOWNLIGHTS



**ZOE 20**  
20W IP44

### STEPLIGHTS



**BIRDIE**  
1W IP40



**BIRDIE TRIMLESS**  
1W IP40

### LINEAR SYSTEM



**ESME  
PRECISION T10**  
10W IP20



**ESME  
PRECISION T20**  
20W IP20



**ESME  
PERFORMANCE T10**  
10W IP20



**ESME  
PERFORMANCE T20**  
20W IP20

### CEILING MOUNTED



**CYL 10**  
10W IP20

### UPLIGHTS & PATHLIGHTS



**LANDA 2**  
2W IP67



**FRONK**  
2W IP67



**NEXUS 6**  
6W IP67

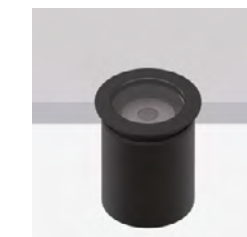

**NEXUS 10**  
10W IP67

# DIM TO WARM



**FLEXUS DTW**  
8W IP44



**FRANNY DTW**  
8W IP44



**ZOE DTW**  
8W IP44



**SEXUS UGR DTW**  
8W IP44



**PLEXUS UGR DTW**  
8W IP44

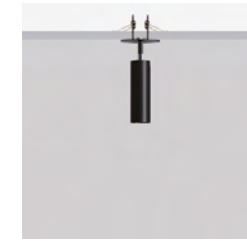

**MINIJOS R DTW**  
8W IP20



**JOS R DTW**  
8W IP20



**LAD R DTW**  
8W IP20



**MINIJOS S DTW**  
8W IP20



**JOS S DTW**  
8W IP20



**LAD S DTW**  
8W IP20

# FLEXUS 20

design: Rod&Todd

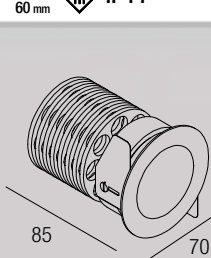

## Flush optic downlight

20W · 500mA (V, 36V)  
CRI95 · 2-Step MacAdam

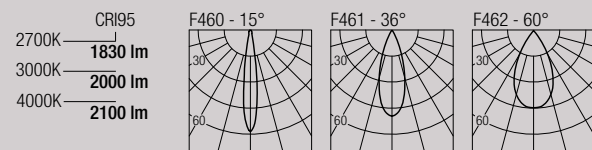

### Code Construction - Costruzione del codice

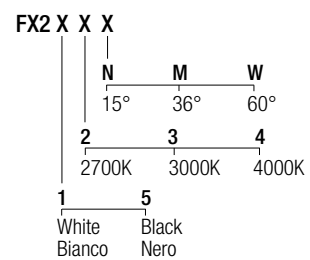

### Accessories - Accessori

**LFX201**  
Low luminance louver  
Filtro antiabbagliamento



**SFX201**  
Milky screen - Schermo opale



Note - Nota  
The filter and the screen must be ordered together with the lighting fixture - Il filtro e lo schermo devono essere ordinati congiuntamente all'apparecchio.

### Drivers - Alimentatori 500mA

- on/off
- AL1084** (1) IP20 S.P. ⌀ 55 mm
- dimmmable
- AL4010** (1) IP20 PUSH 0/1..10V ⌀ 72 mm
  - ALB451** (1) IP20 DALI 2 PUSH ⌀ 46 mm
  - AL4151** (1) IP20 DALI 2 ⌀ 72 mm
  - AL4153** (1) IP20 PUSH IGBT-TRIAC ⌀ 56 mm



# FRANNY 20

design: Rod&Todd

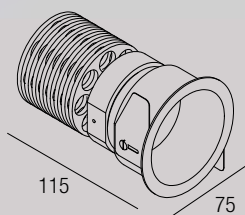

## Recessed optic downlight

20W · 500mA (V, 36V)  
CRI95 · 2-Step MacAdam

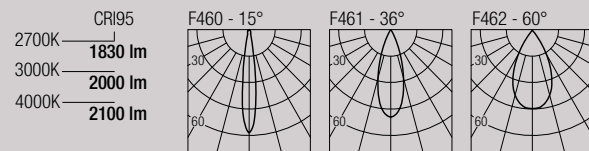

### Code Construction - Costruzione del codice

FN2 X X X	
N	M W
15°	36° 60°
2	3 4
2700K	3000K 4000K
1	5
White Bianco	Black Nero

### Accessories - Accessori

**LFN201**  
Low luminance louver  
Filtro antiabbagliamento



**SFN201**  
Milky screen - Schermo opale



Note - Nota  
The filter and the screen must be ordered together with the lighting fixture - Il filtro e lo schermo devono essere ordinati congiuntamente all'apparecchio.

### Drivers - Alimentatori 500mA

- on/off  
**AL1084** (1) IP20 S.P. ∅55 mm
- dimmiabile  
**AL4010** (1) IP20 PUSH 0/1..10V ∅72 mm  
**ALB451** (1) IP20 DALI 2 PUSH ∅46 mm  
**AL4151** (1) IP20 DALI 2 ∅72 mm  
**AL4153** (1) IP20 PUSH IGBT-TRIAC ∅56 mm



# ZOE 20

design: Rod&Todd

IP44

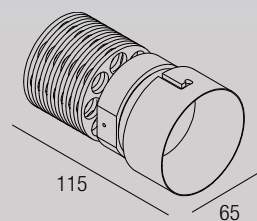

**Trimless downlight**  
20W · 500mA (V, 36V)  
CRI95 · 2-Step MacAdam

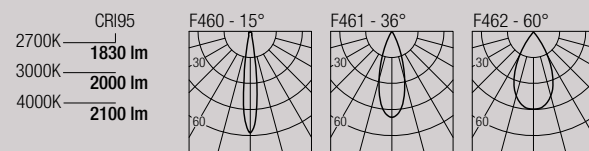

Code Construction - Costruzione del codice

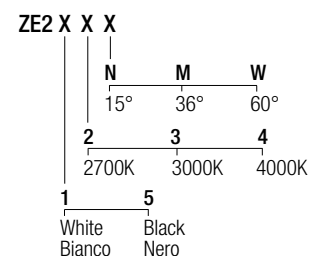

Accessories - Accessori

**ZQSU002** White - Bianco  
**ZQSU002B** Black - Nero  
Plasterboard recessing frame  
Flangia per cartongesso

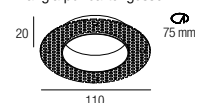

**LZE201**  
Low luminance louver  
Filtro antiabbagliamento



**SZE201**  
Milky screen - Schermo opale



Note - Nota  
The filter and the screen must be ordered together with the lighting fixture - Il filtro e lo schermo devono essere ordinati congiuntamente all'apparecchio.

Drivers - Alimentatori 500mA

- on/off  
**AL1084** (1) IP20 S.P. ⌀ 55 mm  
dimmiabile  
**AL4010** (1) IP20 PUSH 0/1..10V ⌀ 72 mm  
**ALB451** (1) IP20 DALI 2 PUSH ⌀ 46 mm  
**AL4151** (1) IP20 DALI 2 ⌀ 72 mm  
**AL4153** (1) IP20 PUSH IGBT-TRIAC ⌀ 56 mm



# BIRDIE

design: Jude Allen



## Steplight

1-2W · 350-500mA (V, 2,9V) · Series wiring - Cablaggio in serie  
CRI85 · 2-Step MacAdam

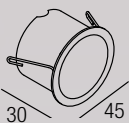

	350mA	500mA
2700K	116 lm	166 lm
3000K	124 lm	177 lm
4200K	137 lm	204 lm

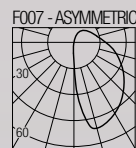

### Code Construction - Costruzione del codice

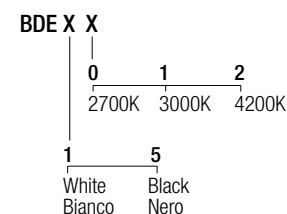

### Accessories - Accessori

#### CSDS05

Recessing box - Controcassa

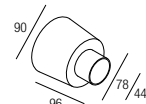

#### AL7022

24VDC/500mA constant current converter  
Convertitore 24VDC/500mA corrente costante

### Drivers - Alimentatori 350mA

- on/off  
**AL1034** (1..11) IP20 ⌀ 30 mm  
**AL1035** (1..11) IP20 ⌀ 40 mm  
**AL1037** (1..16) IP20 S.P. ⌀ 55 mm
- dimmable  
**AL4000** (1..12) IP20 PUSH 0/1..10V ⌀ 72 mm  
**ALD435** (1..11) IP20 DALI 2 PUSH ⌀ 36 mm  
**AL4051** (2..14) IP20 DALI 2 ⌀ 72 mm  
**AL4053** (1..14) IP20 PUSH IGBT-TRIAC ⌀ 56 mm

### Drivers - Alimentatori 500mA

- on/off  
**AL1074** (1..7) IP20 ⌀ 30 mm  
**AL1077** (1..6) IP20 ⌀ 40 mm  
**AL1084** (1..11) IP20 S.P. ⌀ 55 mm
- dimmable  
**AL4010** (1..12) IP20 PUSH 0/1..10V ⌀ 72 mm  
**ALD450** (1..7) IP20 DALI 2 PUSH ⌀ 36 mm  
**AL4151** (2..14) IP20 DALI 2 ⌀ 72 mm  
**AL4153** (1..14) IP20 PUSH IGBT-TRIAC ⌀ 56 mm

# BIRDIE TRIMLESS

design: Jude Allen



## Trimless steplight

1-2W · 350-500mA (V, 2,9V) · Series wiring - Cablaggio in serie  
CRI85 · 2-Step MacAdam

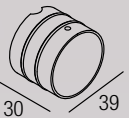

	350mA	500mA
2700K	116 lm	166 lm
3000K	124 lm	177 lm
4200K	137 lm	204 lm

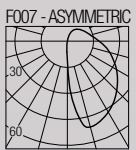

### Code Construction - Costruzione del codice

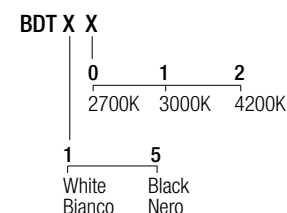

### Accessories - Accessori

#### BQC001 White - Bianco

#### BQC001B Black - Nero

Plasterboard recessing frame  
Flangia per cartongesso

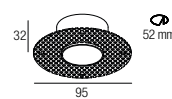

#### AL7022

24VDC/500mA constant current converter  
Convertitore 24VDC/500mA corrente costante

### Drivers - Alimentatori 350mA

- on/off  
**AL1034** (1..11) IP20 ⌀ 30 mm  
**AL1035** (1..11) IP20 ⌀ 40 mm  
**AL1037** (1..16) IP20 S.P. ⌀ 55 mm
- dimmable  
**AL4000** (1..12) IP20 PUSH 0/1..10V ⌀ 72 mm  
**ALD435** (1..11) IP20 DALI 2 PUSH ⌀ 36 mm  
**AL4051** (2..14) IP20 DALI 2 ⌀ 72 mm  
**AL4053** (1..14) IP20 PUSH IGBT-TRIAC ⌀ 56 mm

### Drivers - Alimentatori 500mA

- on/off  
**AL1074** (1..7) IP20 ⌀ 30 mm  
**AL1077** (1..6) IP20 ⌀ 40 mm  
**AL1084** (1..11) IP20 S.P. ⌀ 55 mm
- dimmable  
**AL4010** (1..12) IP20 PUSH 0/1..10V ⌀ 72 mm  
**ALD450** (1..7) IP20 DALI 2 PUSH ⌀ 36 mm  
**AL4151** (2..14) IP20 DALI 2 ⌀ 72 mm  
**AL4153** (1..14) IP20 PUSH IGBT-TRIAC ⌀ 56 mm





# ESME PRECISION T10

design: Jude Allen

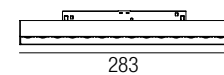

**Linear module for 24VDC tracks**  
10W · 24VDC  
CRI95 · 3-Step MacAdam

2700K — **946 lm**  
3000K — **1005 lm**  
4000K — **1157 lm**

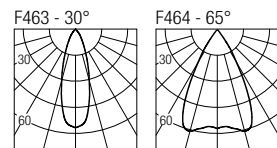

Code Construction - Costruzione del codice

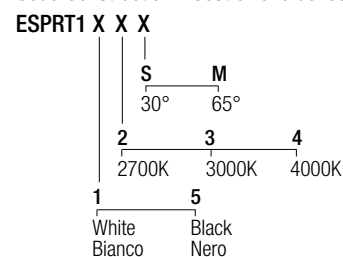

# ESME PERFORMANCE T10

design: Jude Allen

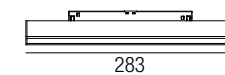

**Linear module for 24VDC tracks**  
10W · 24VDC  
CRI95 · 3-Step MacAdam

2700K — **825 lm**  
3000K — **865 lm**  
4000K — **985 lm**

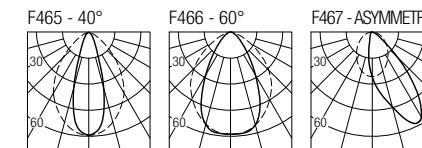

Code Construction - Costruzione del codice

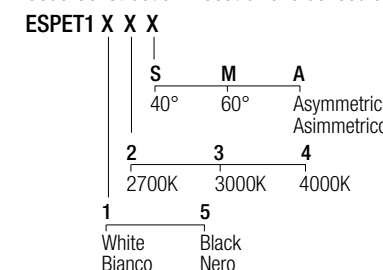

# ESME PRECISION T20

design: Jude Allen

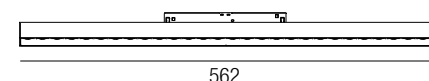

**Linear module for 24VDC tracks**  
20W · 24VDC  
CRI95 · 3-Step MacAdam

2700K — **1892 lm**  
3000K — **2010 lm**  
4000K — **2314 lm**

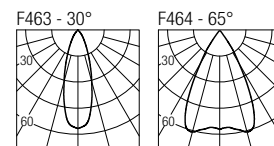

Code Construction - Costruzione del codice

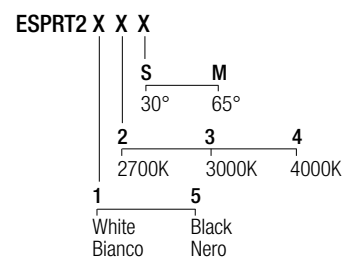

# ESME PERFORMANCE T20

design: Jude Allen



**Linear module for 24VDC tracks**  
20W · 24VDC  
CRI95 · 3-Step MacAdam

2700K — **1650 lm**  
3000K — **1730 lm**  
4000K — **1970 lm**

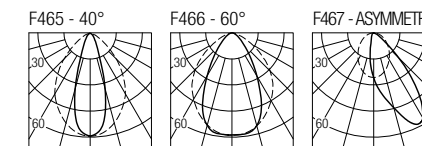

Code Construction - Costruzione del codice

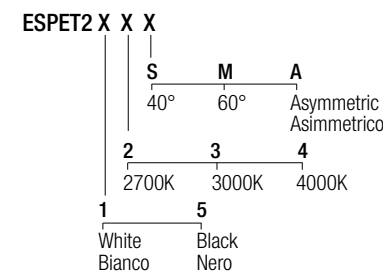

# CYL 10

design: Roberto Mantovani



## Ceiling mounted luminaire

10W · 500mA (V, 18V) · Series wiring - Cablaggio in serie  
CRI85 - CRI93 · 2-Step MacAdam

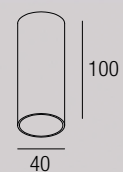

	CRI85	CRI93
2700K	890 lm	840 lm
3000K	1000 lm	930 lm
4000K	1040 lm	960 lm

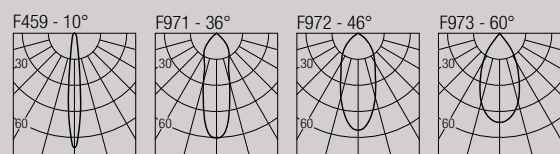

## Code Construction - Costruzione del codice

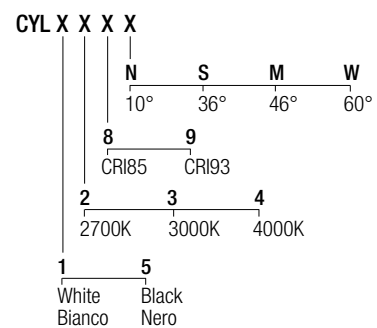

## Accessories - Accessori

**LCYL01** White - Bianco  
**LCYL01B** Black - Nero  
Low luminance louver  
Filtro antiabbagliamento



**SCYL01** White - Bianco  
**SCYL01B** Black - Nero  
Milky screen - Schermo opale



Note - Nota  
The filter and screen are not compatible with the 10° lens version - Il filtro e lo schermo non sono compatibili con la versione con ottica 10°.

**AL7022**  
24VDC/500mA constant current converter  
Convertitore 24VDC/500mA corrente costante

## Drivers - Alimentatori 500mA

on/off  
**AL1074** (1) IP20 ⌀ 30 mm  
**AL1077** (1) IP20 ⌀ 40 mm  
**AL1084** (1..2) IP20 S.P. ⌀ 55 mm  
dimmmable  
**AL4010** (1..2) IP20 PUSH 0/1..10V ⌀ 72 mm  
**ALD450** (1) IP20 DALI 2 PUSH ⌀ 36 mm  
**AL4151** (1..2) IP20 DALI 2 ⌀ 72 mm  
**AL4153** (1..2) IP20 PUSH IGBT-TRIAC ⌀ 56 mm



# LANDA 2

design: Roberto Mantovani

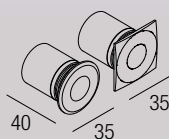

### Uplight

2W · 500mA (V, 2,9V) · Series wiring - Cablaggio in serie  
CRI85 · 2-Step MacAdam

2700K	175 lm
3000K	181 lm
4200K	197 lm
6000K	211 lm

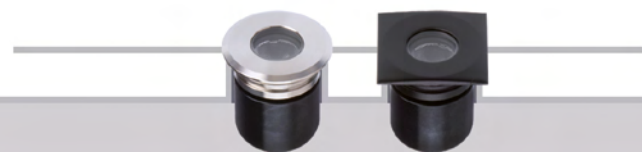
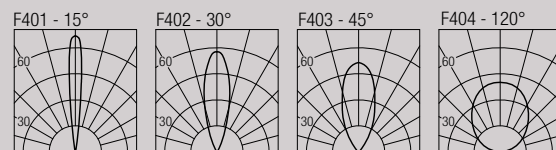

### Code Construction - Costruzione del codice

L2	A	X	X	X	X				
	G	N	K	Z					
	Grey Grigio	Black Nero	COR-TEN	INOX Steel AISI 316L					
	0	1	2	3	6	7	8		
	2700K	3000K	4200K	6000K	Blue Blu	Green Verde	Red Rosso		
	1	2	3	9					
	15°	30°	45°	120°					
1	2								
Round Tondo	Square Quadrato								

### Accessories - Accessori

#### CSLN01

Recessing box - Controcassa

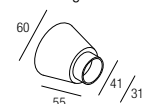

#### LL2A01

Low luminance louver  
Filtro antiabbagliamento



Note - Nota  
The filter must be ordered together with the lighting fixture. Il filtro deve essere ordinato congiuntamente all'apparecchio.

Note - Nota  
Made-to-measure cable available on request. Cavo a misura disponibile su richiesta.

### Drivers - Alimentatori 500mA

on/off

AL1074 (1..7) IP20 ⌀ 30 mm

AL1077 (1..6) IP20 ⌀ 40 mm

AL1084 (1..11) IP20 S.P. ⌀ 55 mm

AL9051 (1..11) IP67 ⌀ 44 mm

dimmable

AL4010 (1..12) IP20 PUSH 0/1..10V ⌀ 72 mm

ALD450 (1..7) IP20 DALI 2 PUSH ⌀ 36 mm

AL4151 (2..14) IP20 DALI 2 ⌀ 72 mm

AL4153 (1..14) IP20 PUSH IGBT-TRIAC ⌀ 56 mm

AL6050 (2..6) IP67 DALI 2 ⌀ 44 mm

AL8050 (4..16) IP67 DALI 2 ⌀ 48 mm

# FRONK

design: Roberto Mantovani

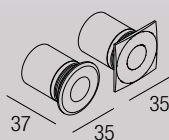

### Uplight

2W · 24VDC · Parallel wiring - Cablaggio in parallelo  
CRI85 · 2-Step MacAdam

2700K	128 lm
3000K	133 lm
4000K	154 lm

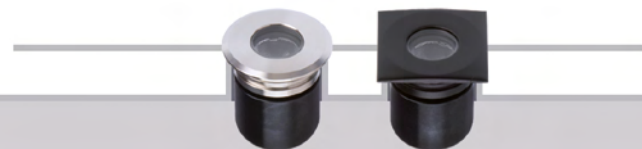
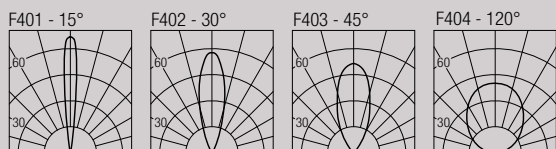

### Code Construction - Costruzione del codice

FNK	X	X	X	X				
	G	N	K	Z				
	Grey Grigio	Black Nero	COR-TEN	INOX Steel AISI 316L				
	0	1	2					
	2700K	3000K	4000K					
	1	2	3	9				
	15°	30°	45°	120°				
1	2							
Round Tondo	Square Quadrato							

### Accessories - Accessori

#### CSLN01

Recessing box - Controcassa

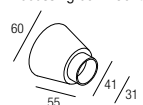

#### LFNK01

Low luminance louver  
Filtro antiabbagliamento



Note - Nota  
The filter must be ordered together with the lighting fixture. Il filtro deve essere ordinato congiuntamente all'apparecchio.

Note - Nota  
Made-to-measure cable available on request. Cavo a misura disponibile su richiesta.

### Drivers - Alimentatori 24VDC

on/off

AL2124 (1..5) IP20 ⌀ 28 mm

AL2012 (1..12) IP20 ⌀ 60 mm

AL2031 (1..35) IP20 ⌀ 70 mm

AL9222 (1..18) IP67 ⌀ 44 mm

AL9231 (1..35) IP67 ⌀ 85 mm

dimmable

AL5012 (1..12) IP20 DALI 2 PUSH 0/1..10V ⌀ 45 mm

AL8012 (1..12) IP67 DALI 2 ⌀ 48 mm

dimming module

AL7035 IP20 DALI 2 PUSH 0/1..10V ⌀ 44 mm

Note - Nota

Dimming module AL7035 to be used in combination with a 24VDC power supply.

Modulo di dimmerazione AL7035 da utilizzare in combinazione con un alimentatore 24VDC.



# NEXUS 6

design: Rod&Todd

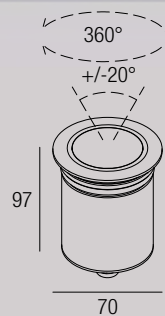

### Adjustable uplight

6W · 500mA (V, 9V) · Series wiring - Cablaggio in serie  
CRI98 · 2-Step MacAdam

2700K **540 lm**  
3000K **600 lm**  
4000K **620 lm**

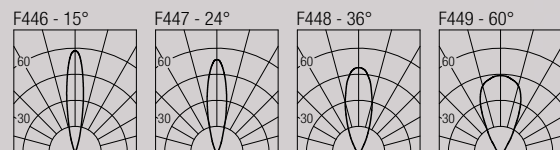

### Code Construction - Costruzione del codice

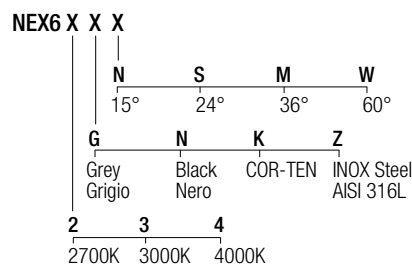

### Accessories - Accessori

**CSXJ01**  
Recessing box - Controcassa

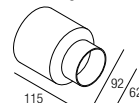

**LNEX601**  
Low luminance louver  
Filtro antiabbagliamento



Note - Nota  
The filter must be ordered together with the lighting fixture.  
Il filtro deve essere ordinato congiuntamente all'apparecchio.

Note - Nota  
Made-to-measure cable available on request.  
Cavo a misura disponibile su richiesta.

### Drivers - Alimentatori 500mA

- on/off  
**AL1074** (1..2) IP20 ⌀ 30 mm  
**AL1077** (1..2) IP20 ⌀ 40 mm  
**AL1084** (1..3) IP20 S.P. ⌀ 55 mm  
**AL9051** (1..3) IP67 ⌀ 44 mm
- dimmmable  
**AL4010** (1..4) IP20 PUSH 0/1..10V ⌀ 72 mm  
**ALD450** (1..2) IP20 DALI 2 PUSH ⌀ 36 mm  
**AL4151** (1..4) IP20 DALI 2 ⌀ 72 mm  
**AL4153** (1..4) IP20 PUSH IGBT-TRIAC ⌀ 56 mm  
**AL6050** (1..2) IP67 DALI 2 ⌀ 44 mm  
**AL8050** (2..4) IP67 DALI 2 ⌀ 48 mm

# NEXUS 10

design: Rod&Todd

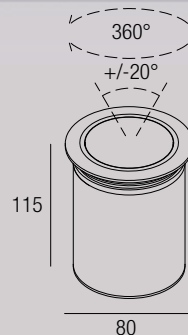

### Adjustable uplight

10W · 500mA (V, 18V) · Series wiring - Cablaggio in serie  
CRI85 - CRI93 · 2-Step MacAdam

2700K **890 lm** **840 lm**  
3000K **1000 lm** **930 lm**  
4000K **1040 lm** **960 lm**

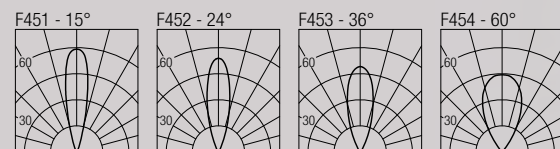

### Code Construction - Costruzione del codice

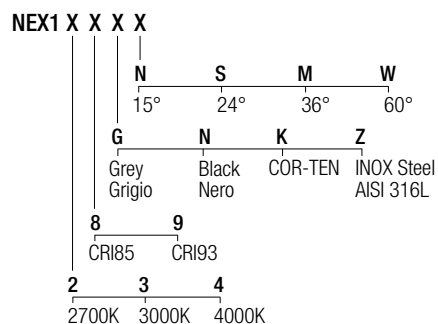

### Accessories - Accessori

**CSXJ02**  
Recessing box - Controcassa

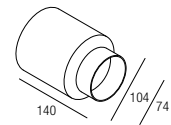

**LNEX101**  
Low luminance louver  
Filtro antiabbagliamento



Note - Nota  
The filter must be ordered together with the lighting fixture.  
Il filtro deve essere ordinato congiuntamente all'apparecchio.

Note - Nota  
Made-to-measure cable available on request.  
Cavo a misura disponibile su richiesta.

### Drivers - Alimentatori 500mA

- on/off  
**AL1074** (1) IP20 ⌀ 30 mm  
**AL1077** (1) IP20 ⌀ 40 mm  
**AL1084** (1..2) IP20 S.P. ⌀ 55 mm  
**AL9051** (1..2) IP67 ⌀ 44 mm
- dimmmable  
**AL4010** (1..2) IP20 PUSH 0/1..10V ⌀ 72 mm  
**ALD450** (1) IP20 DALI 2 PUSH ⌀ 36 mm  
**AL4151** (1..2) IP20 DALI 2 ⌀ 72 mm  
**AL4153** (1..2) IP20 PUSH IGBT-TRIAC ⌀ 56 mm  
**AL6050** (1) IP67 DALI 2 ⌀ 44 mm  
**AL8050** (1..2) IP67 DALI 2 ⌀ 48 mm



# FLEXUS DTW

design: Rod&Todd

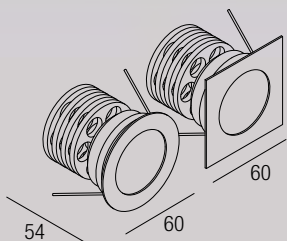

## Flush optic downlight

8W · 400mA (V, 18V) · Series wiring - Cablaggio in serie  
CRI95 · DTW 3000K to 1800K

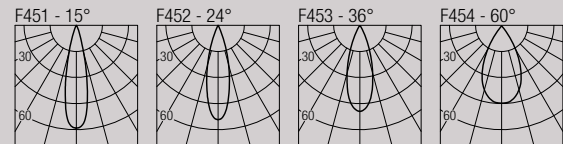
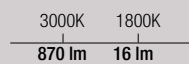

### Code Construction - Costruzione del codice

DTWFX1 X X X

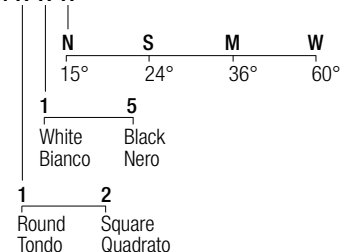

### Accessories - Accessori

CSFX01

Recessing box - Controcassa

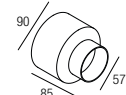

LDFX101

Low luminance louver  
Filtro antiabbagliamento



SDFX101

Milky screen - Schermo opale



Note - Nota  
The filter and the screen must be ordered together with the lighting fixture - Il filtro e lo schermo devono essere ordinati congiuntamente all'apparecchio.



# ZOE DTW

design: Rod&Todd

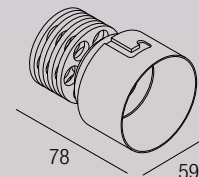

## Trimless downlight

8W · 400mA (V, 18V) · Series wiring - Cablaggio in serie  
CRI95 · DTW 3000K to 1800K

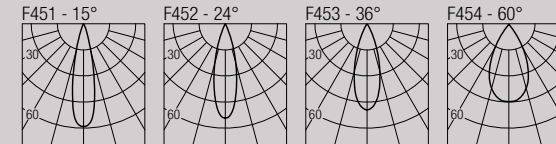
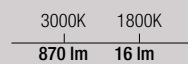

### Code Construction - Costruzione del codice

DTWZE1 X X

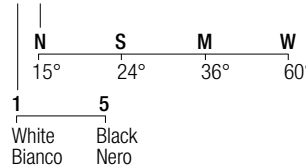

### Accessories - Accessori

ZQC003 White - Bianco

ZQC003B Black - Nero

Plasterboard recessing frame  
Flangia per cartongesso

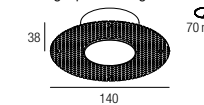

LDZE101

Low luminance louver  
Filtro antiabbagliamento



SDZE101

Milky screen - Schermo opale



Note - Nota  
The filter and the screen must be ordered together with the lighting fixture - Il filtro e lo schermo devono essere ordinati congiuntamente all'apparecchio.



# FRANNY DTW

design: Rod&Todd

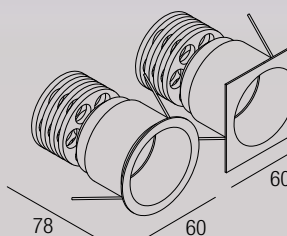

## Recessed optic downlight

8W · 400mA (V, 18V) · Series wiring - Cablaggio in serie  
CRI95 · DTW 3000K to 1800K

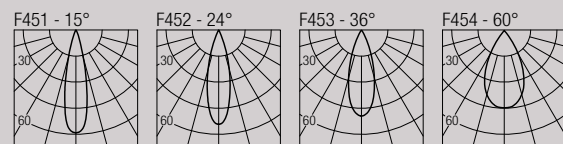

### Code Construction - Costruzione del codice

DTWFN1 X X X

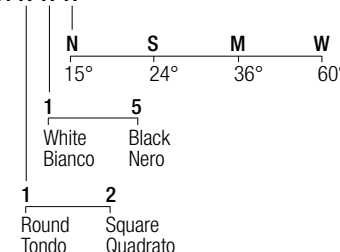

### Accessories - Accessori

CSFX01

Recessing box - Controcassa

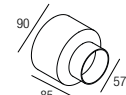

LDFN101

Low luminance louver  
Filtro antiabbagliamento



SDFN101

Milky screen - Schermo opale



Note - Nota  
The filter and the screen must be ordered together with the lighting fixture - Il filtro e lo schermo devono essere ordinati congiuntamente all'apparecchio.

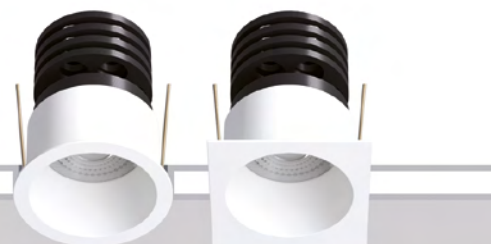

# SEXUS UGR DTW

design: Rod&Todd

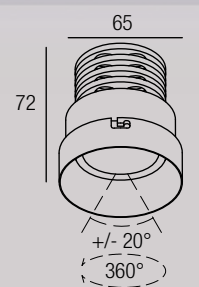

## Trimless & adjustable downlight

8W · 400mA (V, 18V) · Series wiring - Cablaggio in serie  
CRI95 · DTW 3000K to 1800K

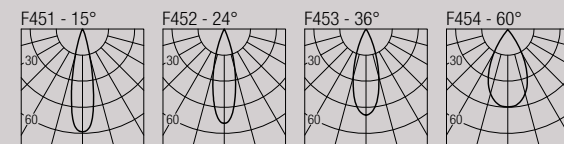
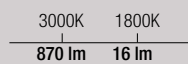

### Code Construction - Costruzione del codice

DTWSXU1 X X

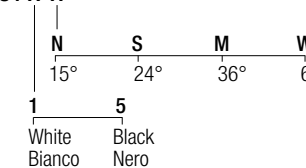

### Accessories - Accessori

ZQSU002 White - Bianco

ZQSU002B Black - Nero

Plasterboard recessing frame  
Flangia per cartongesso

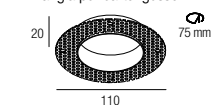

LDSXU101

Low luminance louver  
Filtro antiabbagliamento



SDSXU101

Milky screen - Schermo opale



Note - Nota  
The filter and the screen must be ordered together with the lighting fixture - Il filtro e lo schermo devono essere ordinati congiuntamente all'apparecchio.



# PLEXUS UGR DTW

design: Rod&Todd

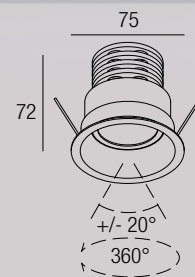

## Adjustable downlight

8W · 400mA (V<sub>i</sub> 18V) · Series wiring - Cablaggio in serie  
CRI95 · DTW 3000K to 1800K

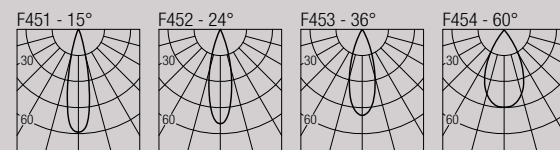
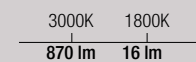

# JOS R DTW

design: Roberto Mantovani

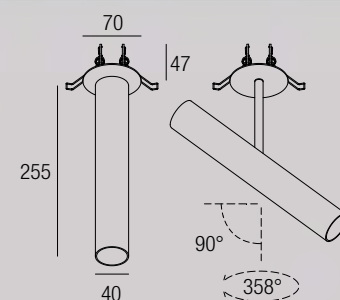

## Semi-recessed projector

8W · 400mA (V<sub>i</sub> 18V) · Series wiring - Cablaggio in serie  
CRI95 · DTW 3000K to 1800K

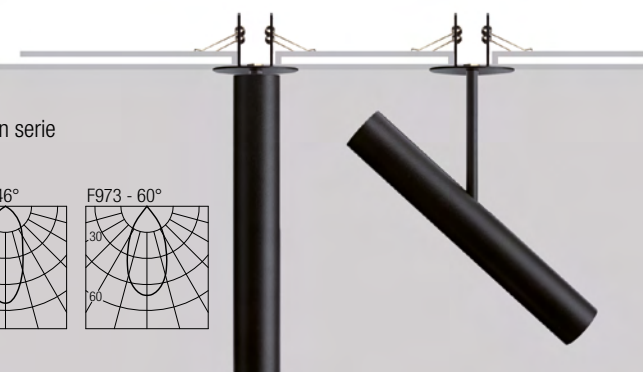
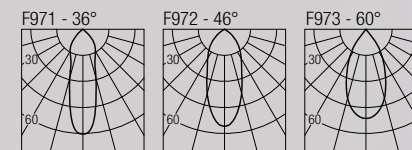
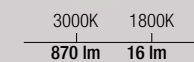

Code Construction - Costruzione del codice

DTWPLXU1 X X

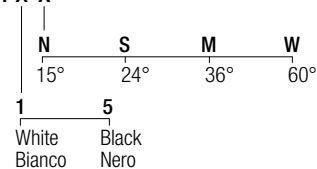

Accessories - Accessori

LDPLXU101

Low luminance louver  
Filtro antiabbagliamento



SDPLXU101

Milky screen - Schermo opale



Note - Nota  
The filter and the screen must be ordered together with the lighting fixture - Il filtro e lo schermo devono essere ordinati congiuntamente all'apparecchio.

Drivers - Alimentatori 400mA

dimmmable  
AL4451 (1..2) IP20 DALI 2 ⌀ 50 mm

Code Construction - Costruzione del codice

DTWJSR1 X X

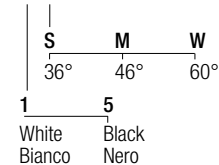

Note - Nota

Versions with extended arm length are available upon request. Versioni con lunghezza del braccetto maggiorata disponibili su richiesta.

Accessories - Accessori

LJ01 White - Bianco  
LJ01B Black - Nero  
Low luminance louver  
Filtro antiabbagliamento



SJ01 White - Bianco  
SJ01B Black - Nero  
Milky screen - Schermo opale



Drivers - Alimentatori 400mA

dimmmable  
AL4451 (1..2) IP20 DALI 2 ⌀ 50 mm

# MINIJOS R DTW

design: Roberto Mantovani

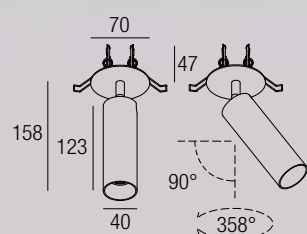

## Semi-recessed projector

8W · 400mA (V<sub>i</sub> 18V) · Series wiring - Cablaggio in serie  
CRI95 · DTW 3000K to 1800K

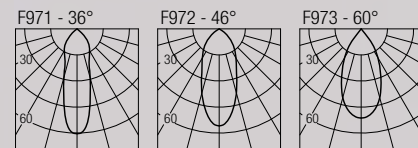
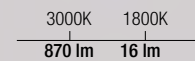

# LAD R DTW

design: Roberto Mantovani

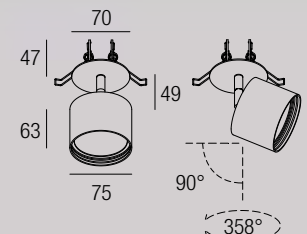

## Semi-recessed projector

8W · 400mA (V<sub>i</sub> 18V) · Series wiring - Cablaggio in serie  
CRI85 - CRI93 · 2-Step MacAdam

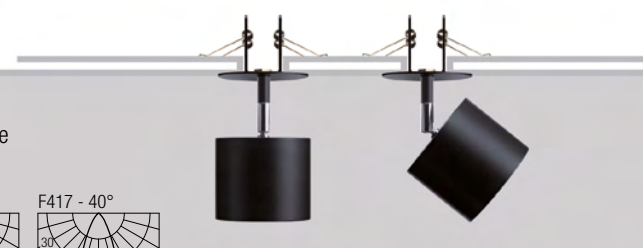
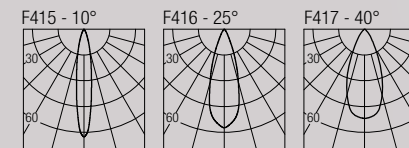
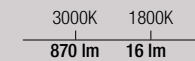

Code Construction - Costruzione del codice

DTWMSR1 X X

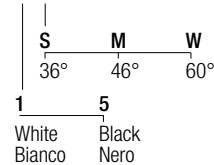

Note - Nota  
Versions with extended arm length are available upon request. Versioni con lunghezza del braccetto maggiorata disponibili su richiesta.

Accessories - Accessori

LJ01 White - Bianco  
LJ01B Black - Nero  
Low luminance louver  
Filtro antiabbagliamento



SJ01 White - Bianco  
SJ01B Black - Nero  
Milky screen - Schermo opale



Drivers - Alimentatori 400mA

dimmmable  
AL4451 (1..2) IP20 DALI 2 ⌀ 50 mm

Code Construction - Costruzione del codice

DTWLADR1 X X

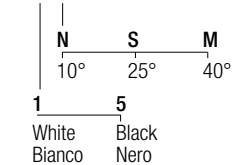

Note - Nota  
Versions with extended arm length are available upon request. Versioni con lunghezza del braccetto maggiorata disponibili su richiesta.

Accessories - Accessori

LL01 White - Bianco  
LL01B Black - Nero  
Low luminance louver  
Filtro antiabbagliamento



SL01 White - Bianco  
SL01B Black - Nero  
Milky screen - Schermo opale



Drivers - Alimentatori 400mA

dimmmable  
AL4451 (1..2) IP20 DALI 2 ⌀ 50 mm

# MINIJOS S DTW

design: Roberto Mantovani

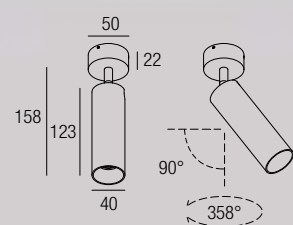

## Surface projector

8W · 400mA (V, 18V) · Series wiring - Cablaggio in serie  
CRI95 · DTW 3000K to 1800K

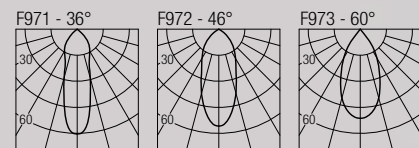

Code Construction - Costruzione del codice

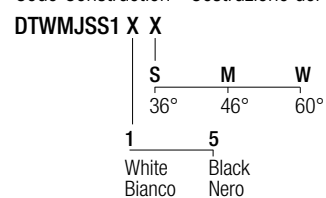

Note - Nota  
Versions with extended arm length are available upon request.  
Versioni con lunghezza del braccetto maggiorata disponibili su richiesta.

Accessories - Accessori

**LJ01** White - Bianco  
**LJ01B** Black - Nero  
Low luminance louver  
Filtro antiabbagliamento



**SJ01** White - Bianco  
**SJ01B** Black - Nero  
Milky screen - Schermo opale



Drivers - Alimentatori 400mA

dimmmable  
**AL4451** (1..2) IP20 DALI 2 ⌀50 mm

# LAD S DTW

design: Roberto Mantovani

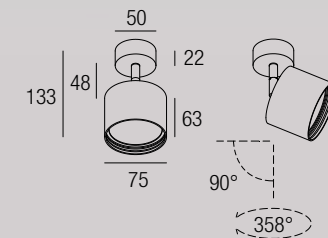

## Surface projector

8W · 400mA (V, 18V) · Series wiring - Cablaggio in serie  
CRI95 · DTW 3000K to 1800K

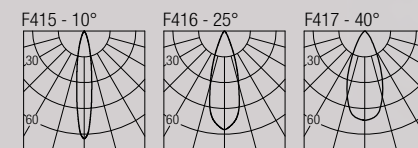

Code Construction - Costruzione del codice

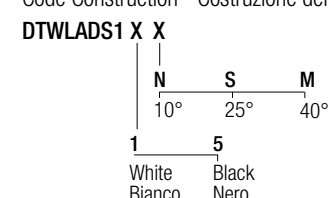

Note - Nota  
Versions with extended arm length are available upon request.  
Versioni con lunghezza del braccetto maggiorata disponibili su richiesta.

Accessories - Accessori

**LL01** White - Bianco  
**LL01B** Black - Nero  
Low luminance louver  
Filtro antiabbagliamento



**SL01** White - Bianco  
**SL01B** Black - Nero  
Milky screen - Schermo opale



Drivers - Alimentatori 400mA

dimmmable  
**AL4451** (1..2) IP20 DALI 2 ⌀50 mm

# JOS S DTW

design: Roberto Mantovani

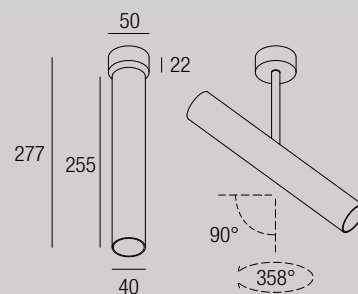

## Surface projector

8W · 400mA (V, 18V) · Series wiring - Cablaggio in serie  
CRI95 · DTW 3000K to 1800K

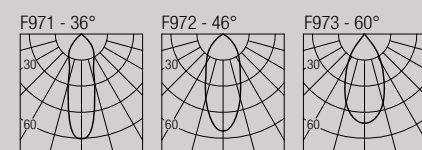

Code Construction - Costruzione del codice

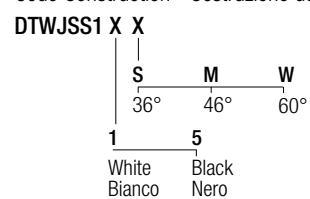

Note - Nota  
Versions with extended arm length are available upon request.  
Versioni con lunghezza del braccetto maggiorata disponibili su richiesta.

Accessories - Accessori

**LJ01** White - Bianco  
**LJ01B** Black - Nero  
Low luminance louver  
Filtro antiabbagliamento



**SJ01** White - Bianco  
**SJ01B** Black - Nero  
Milky screen - Schermo opale



Drivers - Alimentatori 400mA

dimmmable  
**AL4451** (1..2) IP20 DALI 2 ⌀50 mm

# FLEXA LIGHTING

PART OF  
DEXELANCE

Via Lisbona 21  
50065 Pontassieve  
Firenze, Italy

ph +39.055.83.23.021  
fax +39.055.83.24.866

- ▶ [info@flexalighting.it](mailto:info@flexalighting.it)
- ▶ [www.flexalighting.net](http://www.flexalighting.net)

