

MAGGY 72

Linear System

design Lapo Grassellini

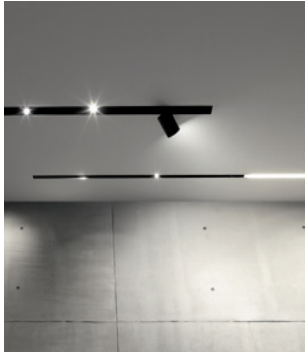

The Maggy linear system allows the trimless installations of 36mm or 72mm width that can be equipped with various light modules fastened to the structure via magnets. The side slots on the duct allow repositioning of the individual elements at any time.

Il sistema lineare Maggy permette la realizzazione di tagli trimless di larghezza 36mm o 72mm, equipaggiabili con moduli luminosi di varie tipologie fissati alla struttura tramite calamite. Le asole laterali presenti sul canale consentono di posizionare gli apparecchi in qualsiasi punto, variandone la posizione in qualsiasi momento.

Le système linéaire Maggy permet la réalisation de coupés trimless de largeur 36 mm ou 72 mm, qui peuvent être équipés de modules lumineux de différentes typologies placés sur la structure par le biais d'aimants. Les fentes latérales présentes sur le canal permettent de positionner les appareils à n'importe quel endroit et de varier la position à tout moment.

Das lineare System Maggy ermöglicht die Herstellung von Einschnitten trimless mit einer Breite von 36 mm oder 72 mm, die mit Lichtmodulen von verschiedener Art ausgestattet werden können, die mit Magneten an der Struktur anhaften. Die seitlichen Ösen an dem Kanal ermöglichen die Positionierung der Geräte an beliebigen Punkten und somit die Veränderung der Position zu jeder Zeit.

El sistema lineal Maggy permite la realización de cortes trimless de 36mm o 72mm de ancho que pueden equiparse con módulos luminosos de distintos tipos fijados a la estructura mediante imanes. Las ranuras laterales presentes en el canal permiten colocar los aparatos en cualquier punto, pudiendo variar su posición en cualquier momento.

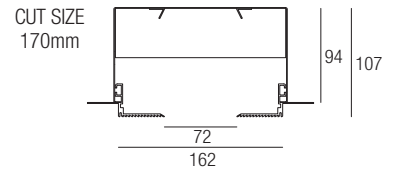

CE made in Italy

Modules

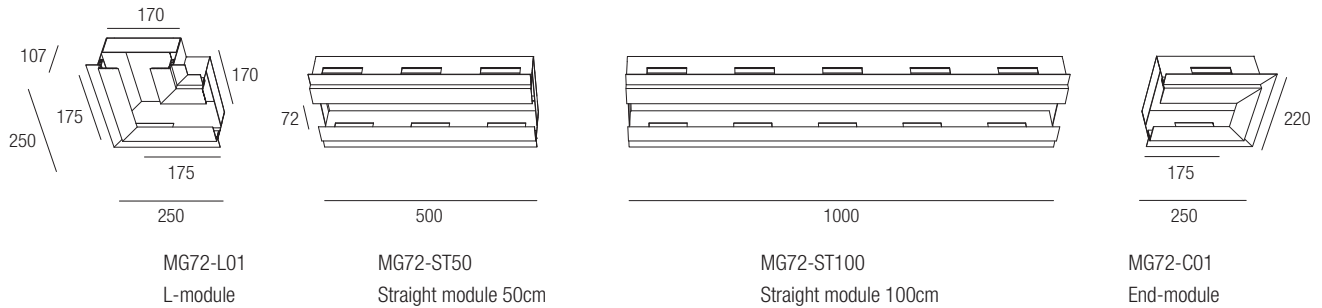

Fixing lighting elements

Wire the product and pass the power supply through the side holes of the duct.

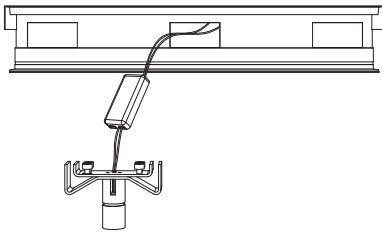

Fix the fall protection cable to the structure.

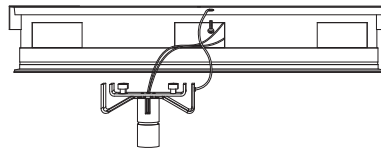

Insert the light module into the structure and position it. The module attaches magnetically.

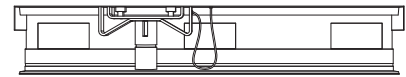

Lighting elements



LEONARD 72
Adjustable module for Maggy 72
10W - 250mA



DAVID 72
Fixed module for Maggy 72
20W - 500mA



PRINCE 72
Adjustable module for Maggy 72
20W - 500mA

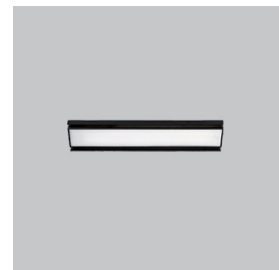

BEN 72
Linear module for Maggy 72
30W - 24VDC