

AL9231



Rated Voltage
Tensione Nominale
220 ÷ 240 V

Frequency
Frequenza
50-60 Hz

AC Operation range
Tensione di utilizzo AC
198 ÷ 264 V

DC Operation range
Tensione di utilizzo DC
176 ÷ 264 V

Power - Potenza
0 ÷ 150 W

iTHD
≤ 10% ⁽¹⁾

Output current ripple
≤ 3% ⁽¹⁾

Standards compliance
EN 50172 (VDE 0108)
EN 55015
EN 61000-3-2
EN 61000-3-3
EN 61347-1
EN 61347-2-13
EN 61547
VDE 0710-T14

In rush current
15A 600μsec

W	V out DC	I out DC	ta °C	tc °C	λ max. Power Factor	η max. Efficiency ⁽¹⁾
70	24	2,90 A max.	-40...+45	70	0,97	> 91

⁽¹⁾ Referred to $V_m = 230$ V, 100% load - Riferito a $V_m = 230$ V, carico 100%

CASE **IP 67** **SCREW FIXING** Weight - Peso gr. 600 / 21,16 oz.

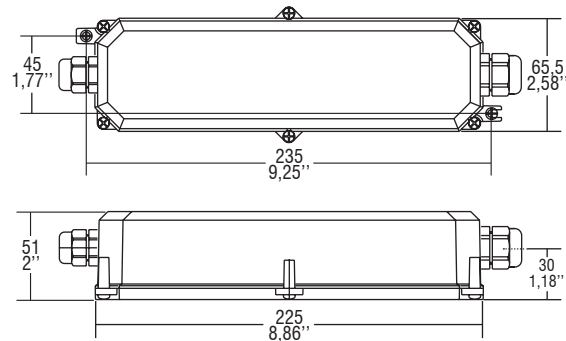

Wiring diagram - Schema di collegamento

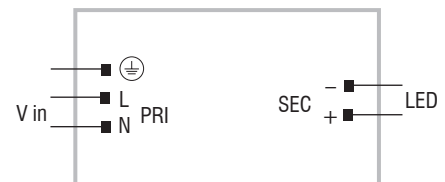

Features

- IP67 independent driver, for outdoor use.
- Class I protection against electric shock for direct or indirect contact.
- Cables on primary and secondary circuits for connection.
- If the input cable is damaged it can only be replaced by authorized personnel.
- Driver can be secured with slot for screws.
- Protections:
 - against overheating and short circuits;
 - against mains voltage spikes;
 - against overloads.
- Conformal Coating available upon request.

Caratteristiche

- Alimentatore indipendente IP67, per uso esterno.
- Protetto in classe I contro le scosse elettriche per contatti diretti e indiretti.
- Fornito di cavi su primario e secondario per il collegamento.
- Se il cavo di rete è danneggiato deve essere sostituito da personale autorizzato.
- Fissaggio dell'alimentatore tramite asole per viti.
- Protezioni:
 - termica e cortocircuito;
 - contro le extra-tensioni di rete;
 - contro i sovraccarichi.
- Tropicalizzazione disponibile su richiesta.